

Wandbild - Ineinander Verwoben

© www.inspiration-for-glass.com

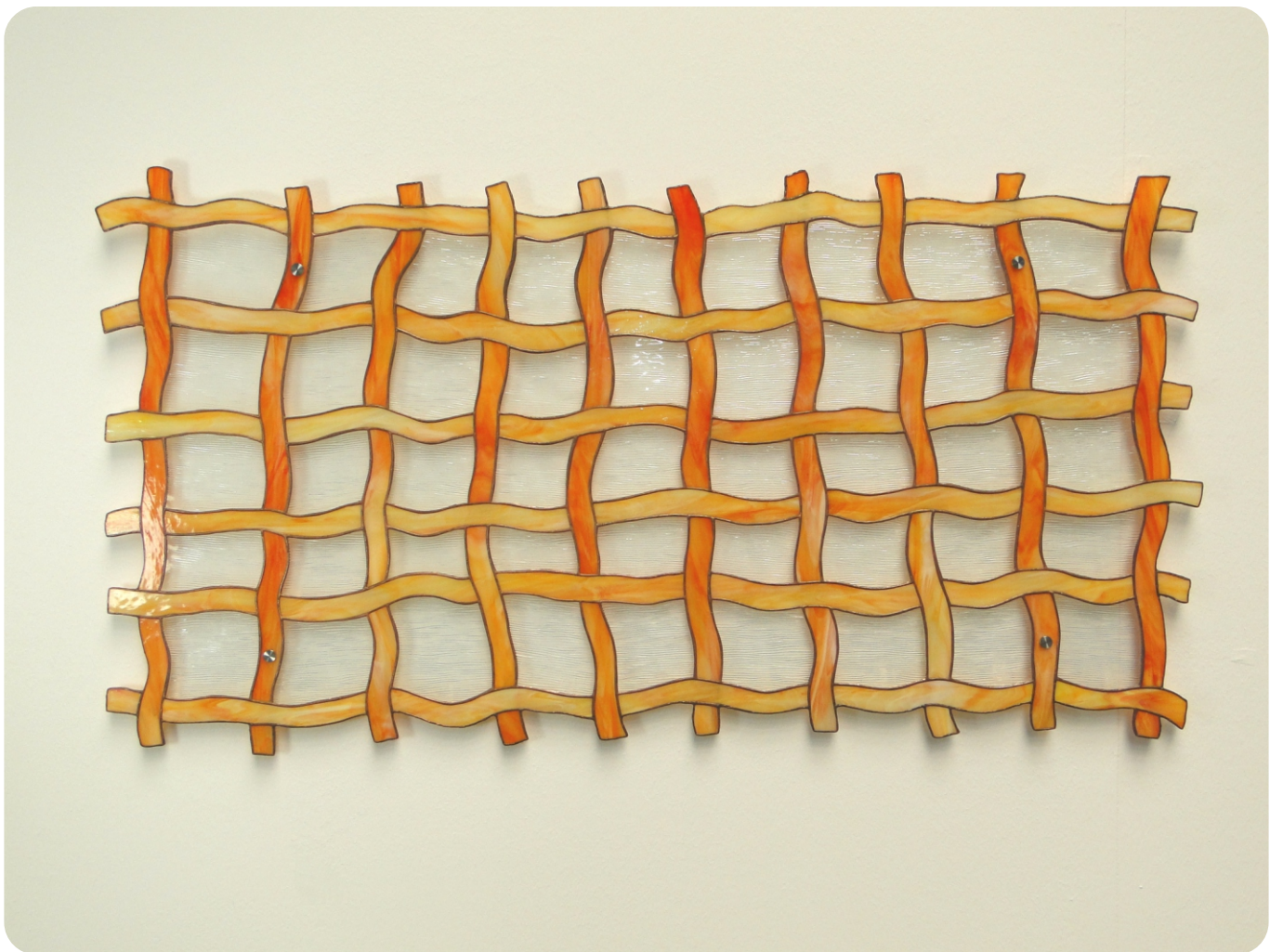

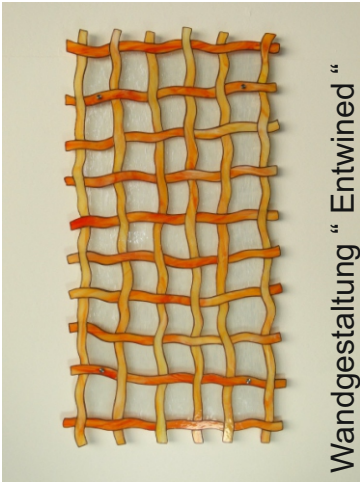

Wandgestaltung "Entwined"

● = hier bohren Sie ein Loch mit ca. 6-7mm Durchmesser.
 Die insgesamt vier Löcher benötigen Sie später zur Montage des Glasbildes an der Wand.
 Montage mit "Distanzhalter ArtNr. 4596100"

Schnittmuster in Originalgröße ca.64 x 120 cm

Glasauswahl Beispiel:

- Teil 1 - 40 : Spectrum 6076-83CC
- Teil 41 - 76 : Spectrum 6067-83CC
- Teil 77 - 121 : Spectrum 100C

● verstärken Sie das Bild umlaufend mit eingelötetem Draht !

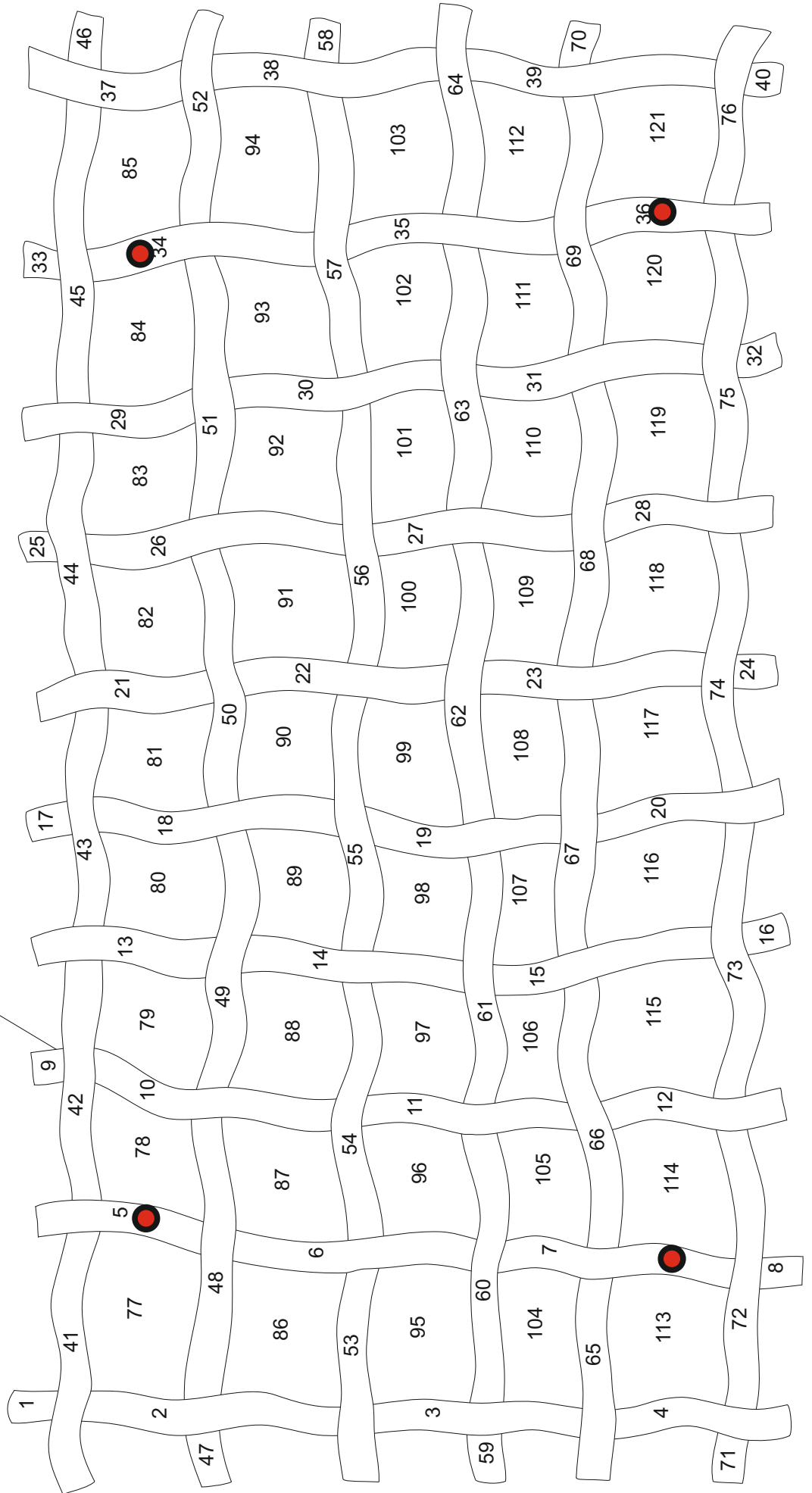

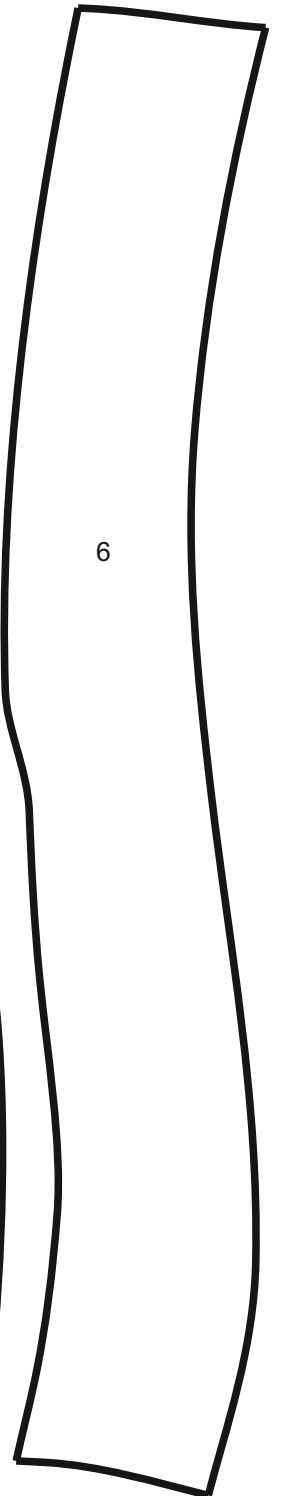
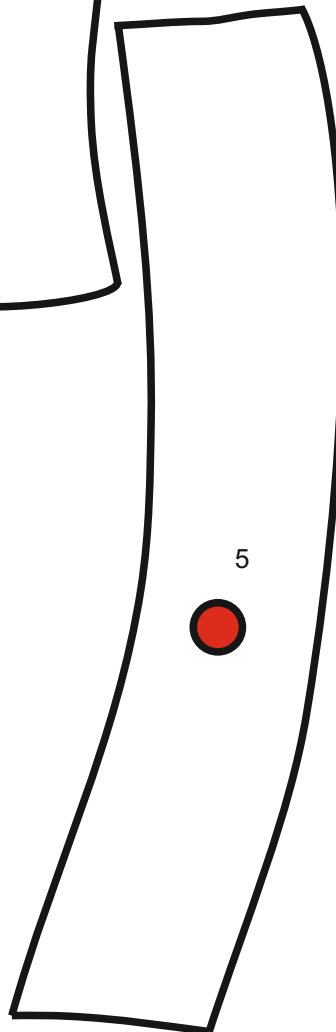
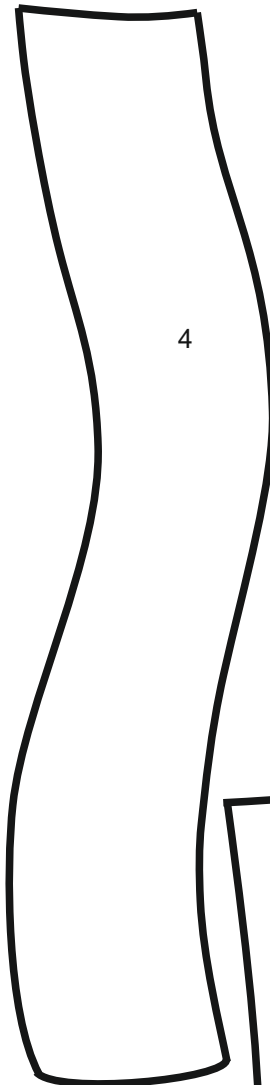
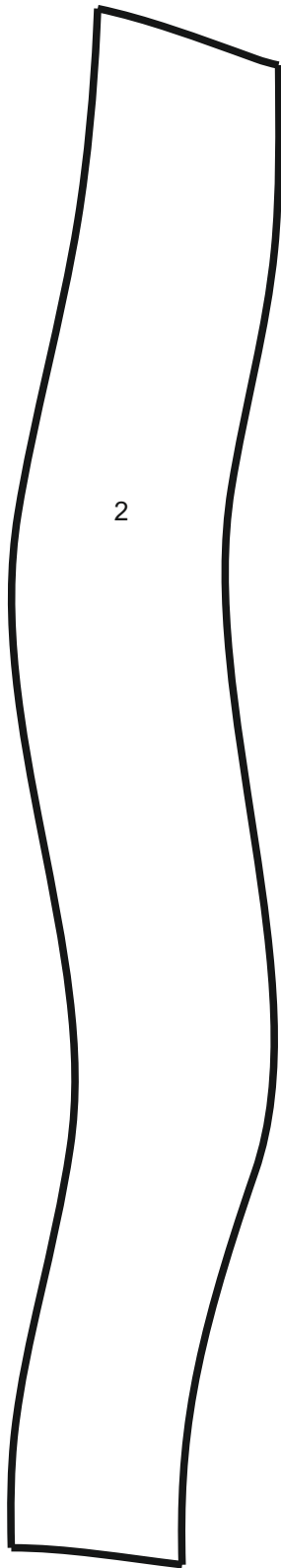
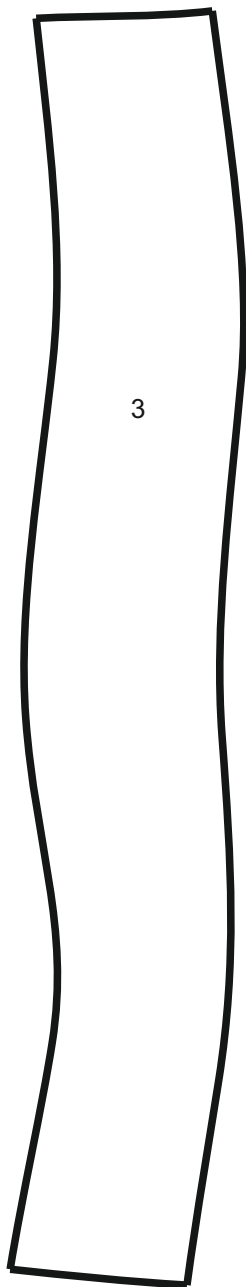
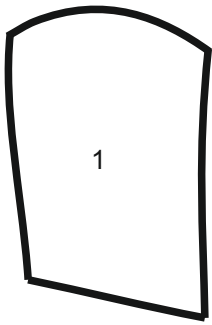

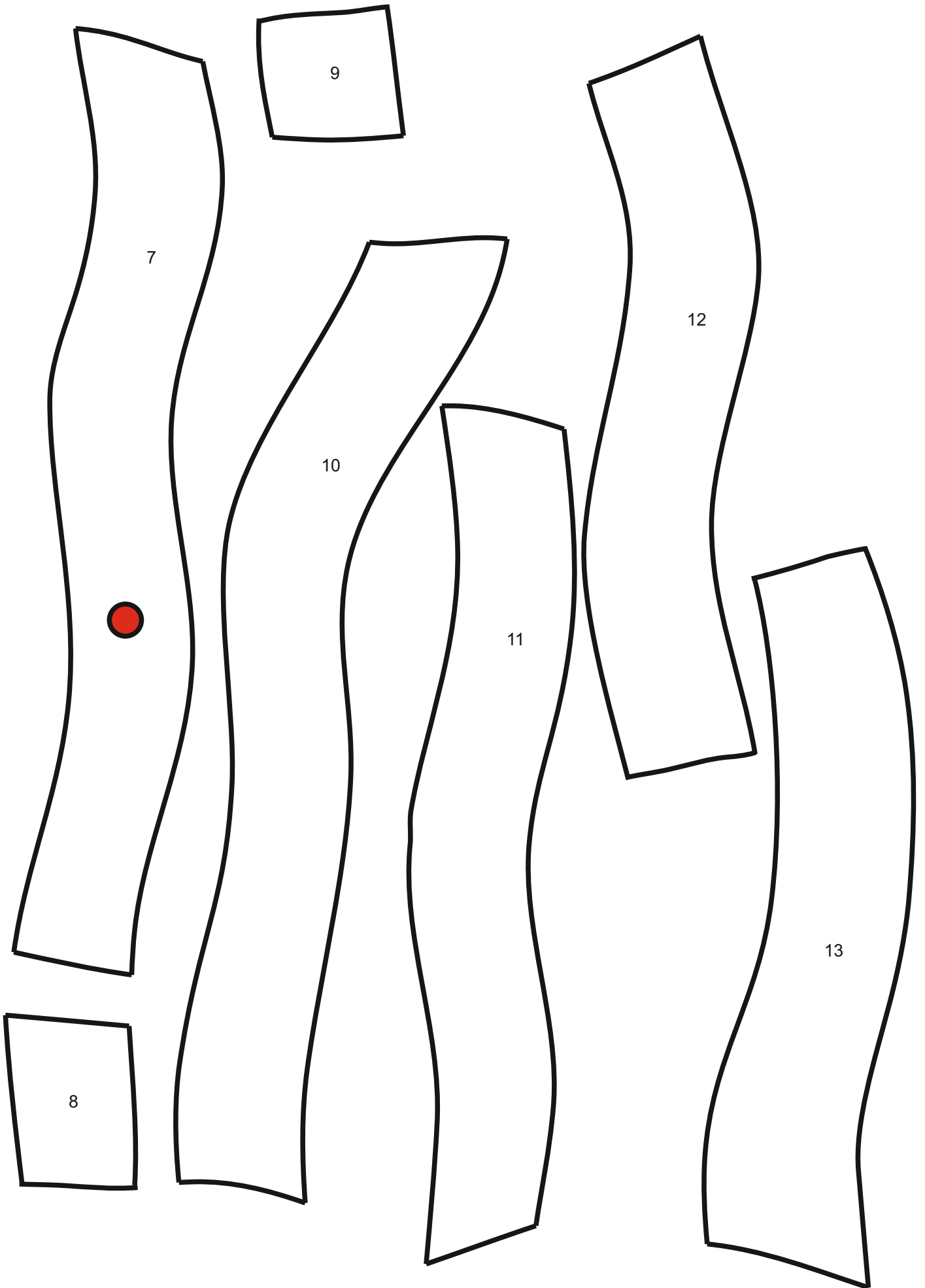

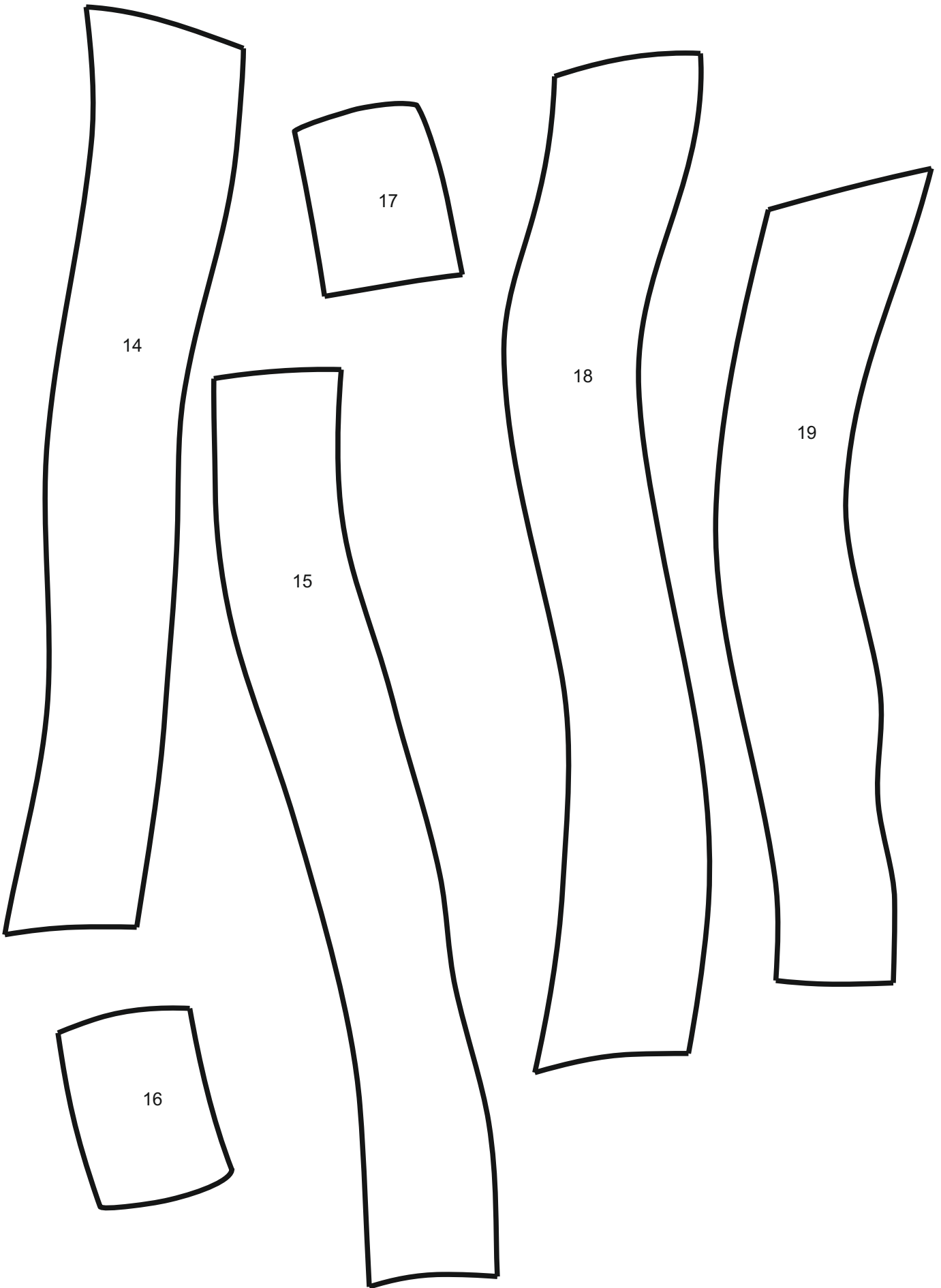

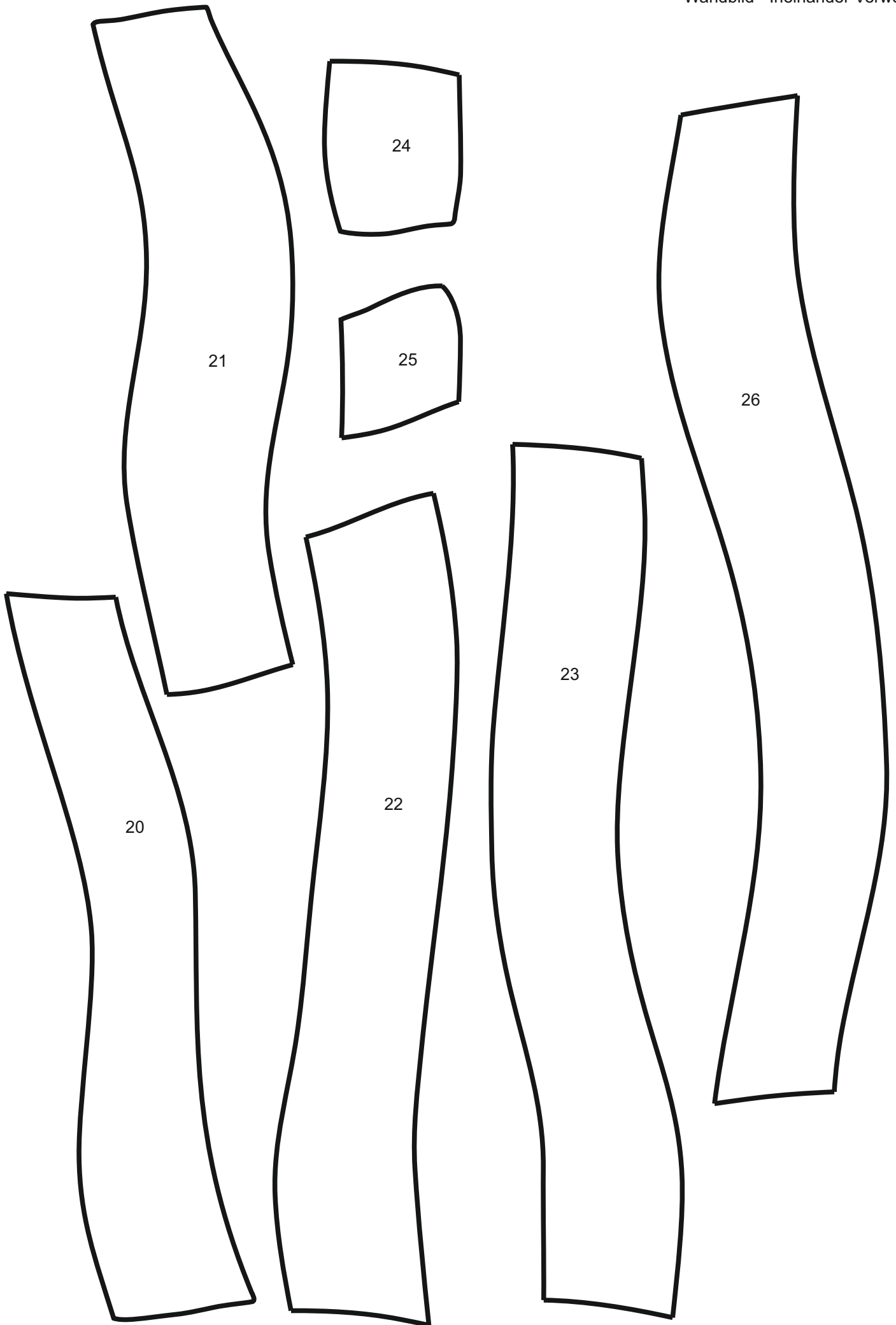

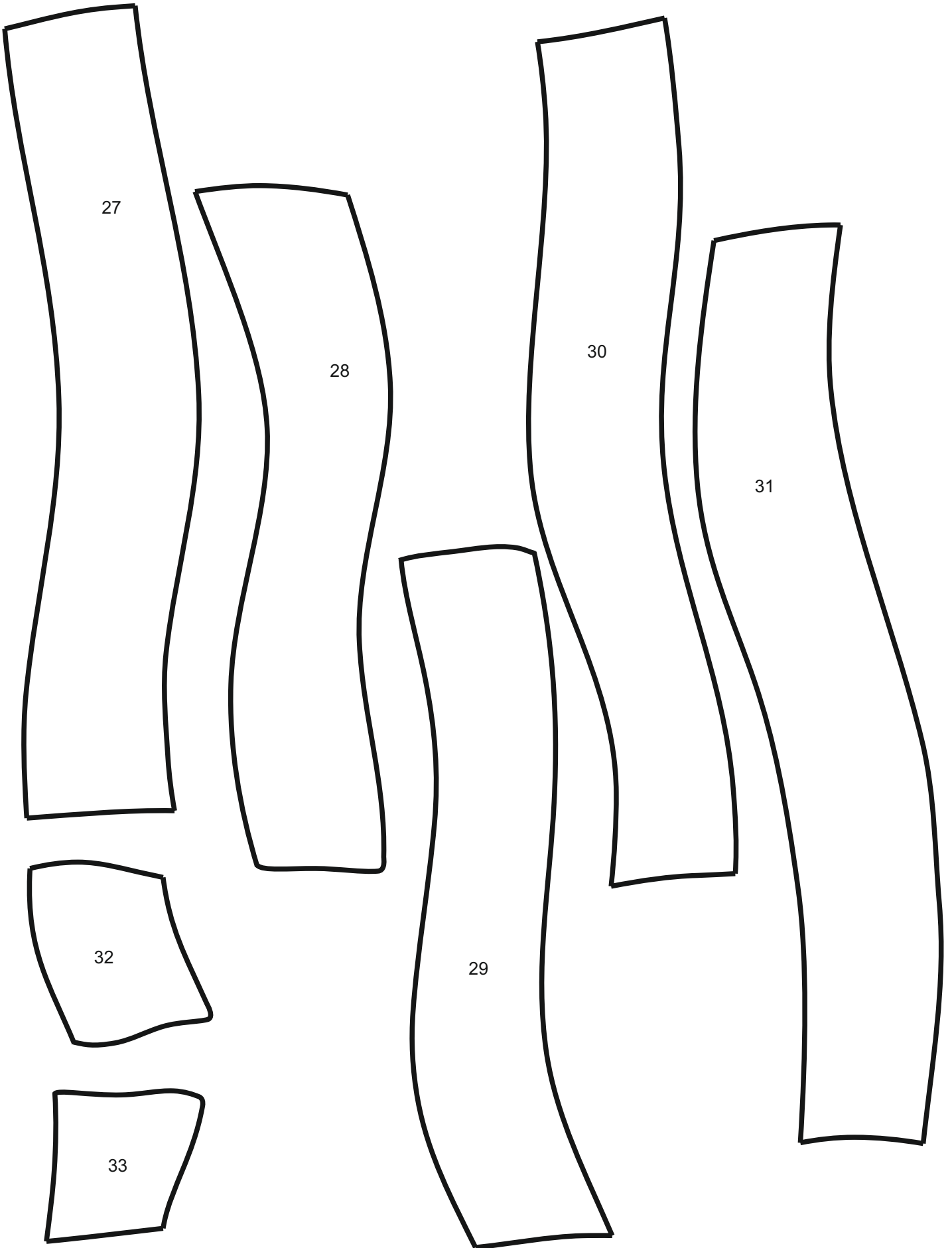

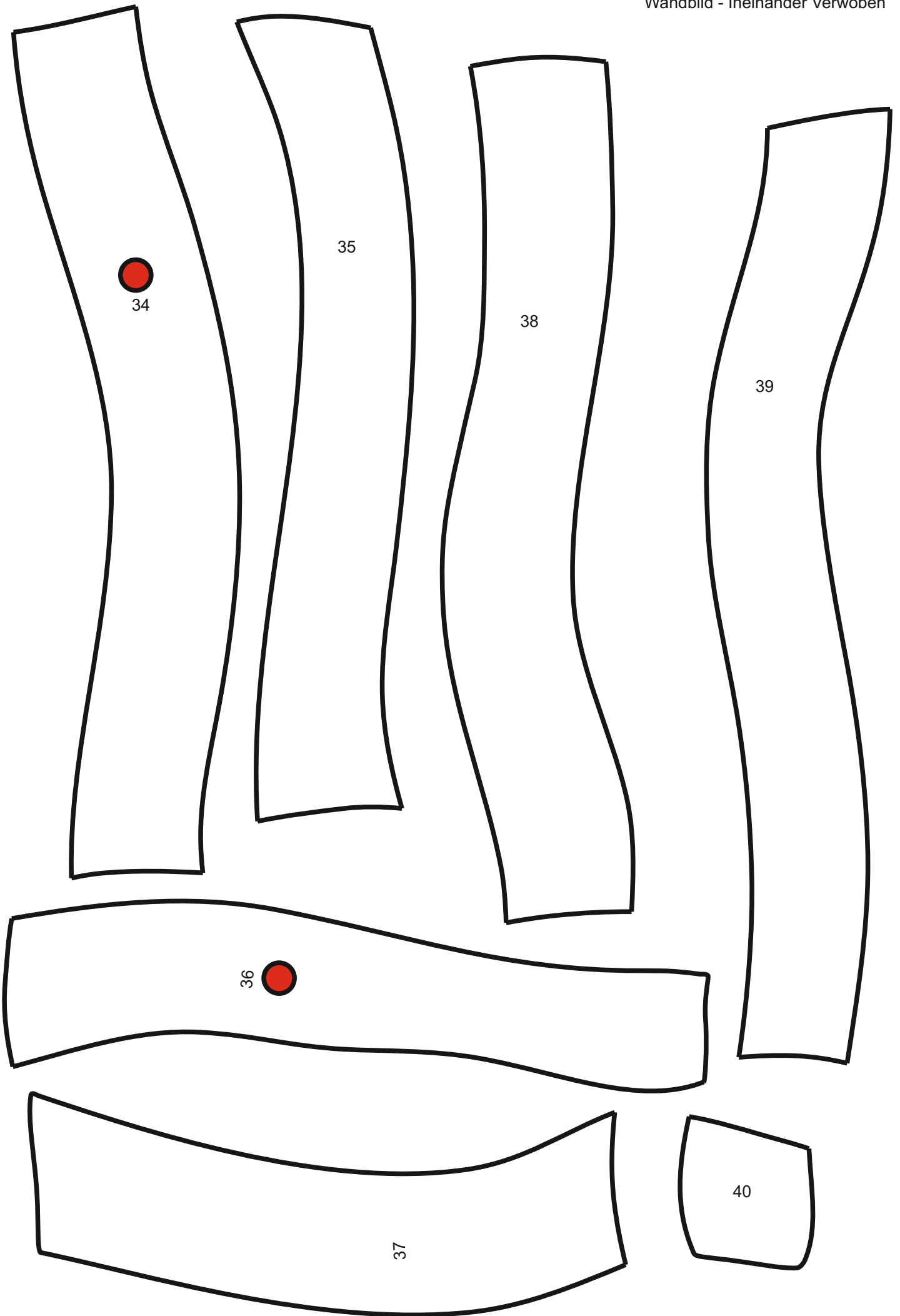

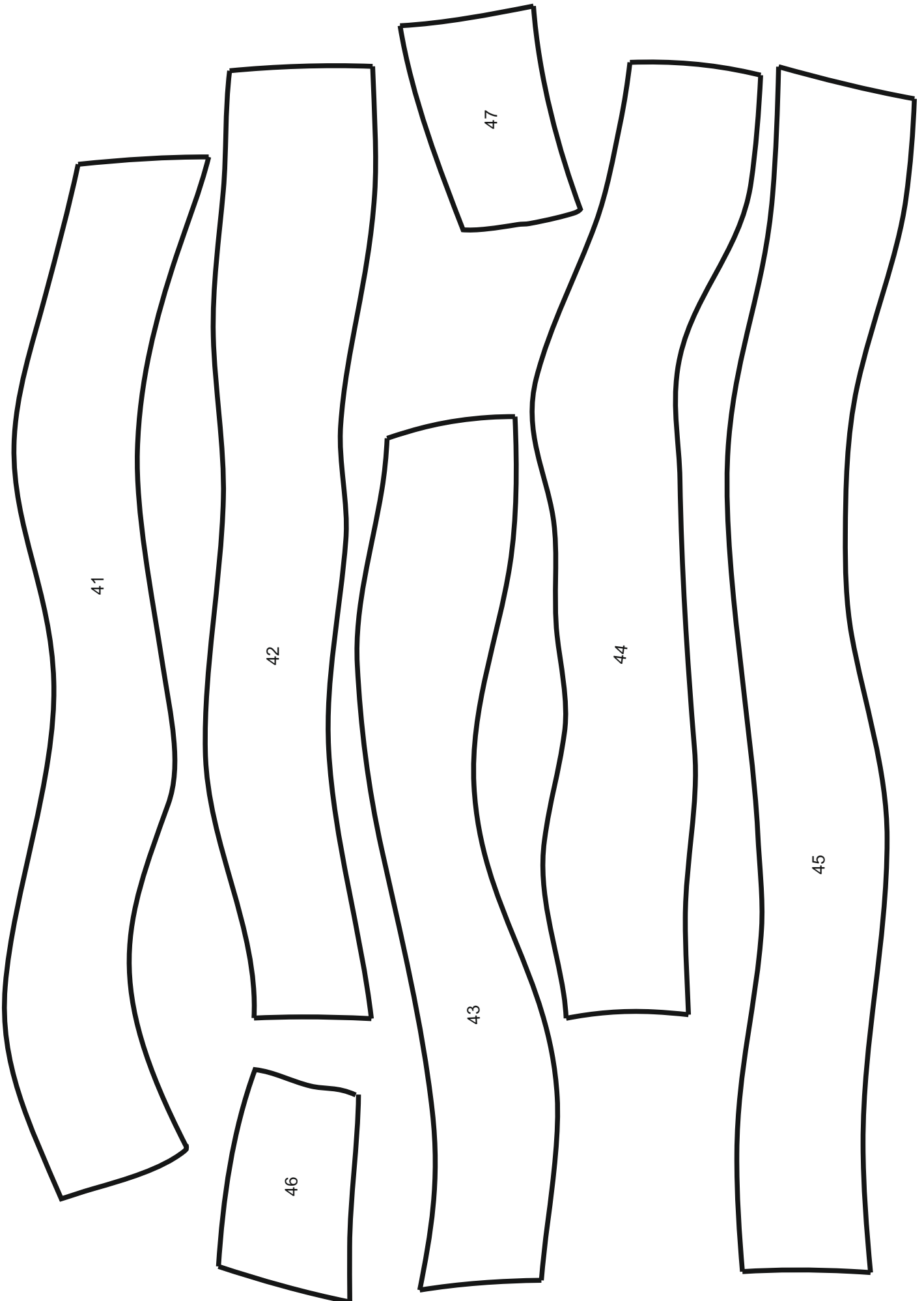

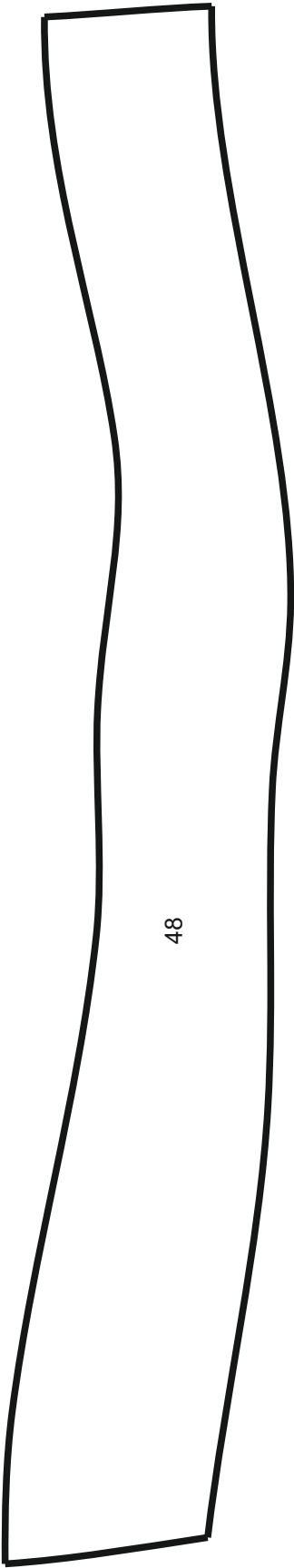

48



49

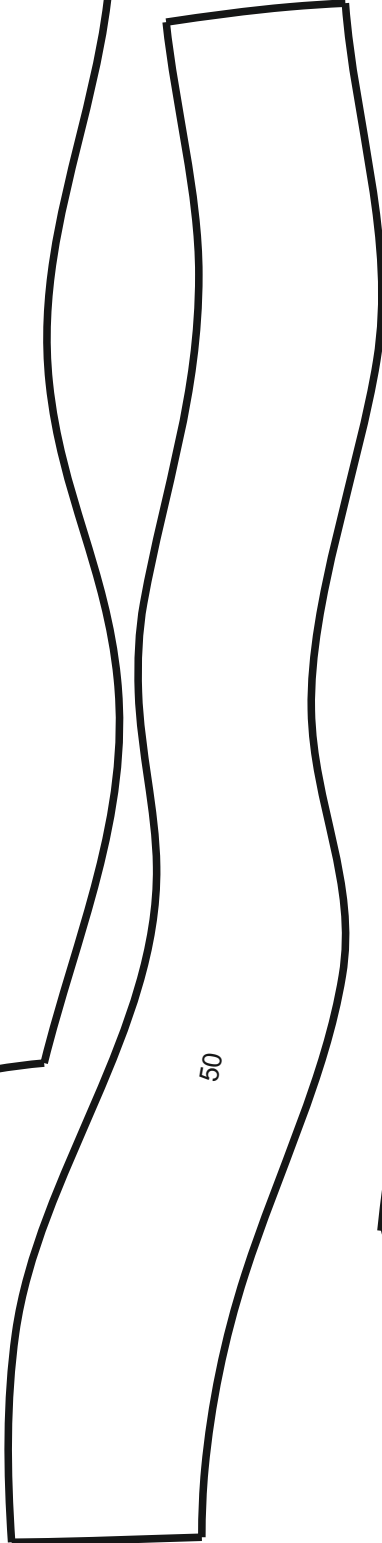

50

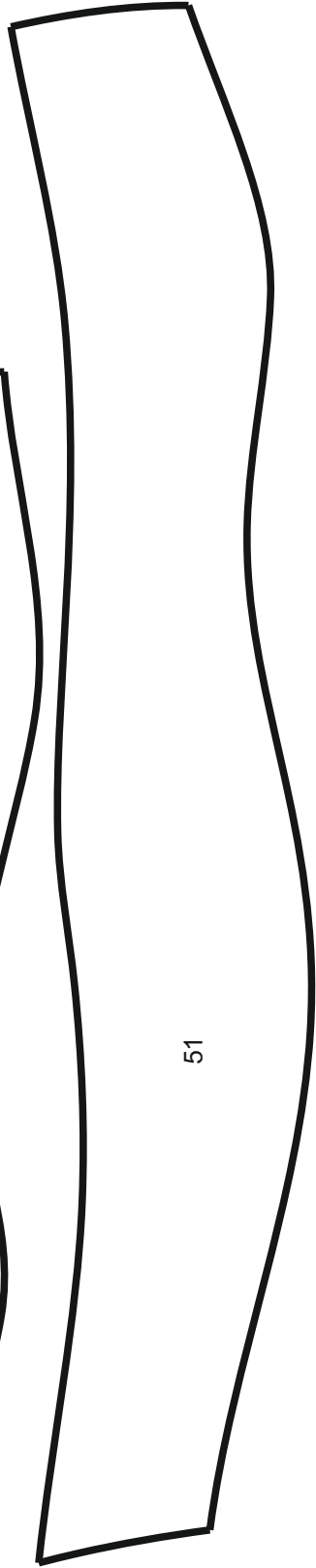

51

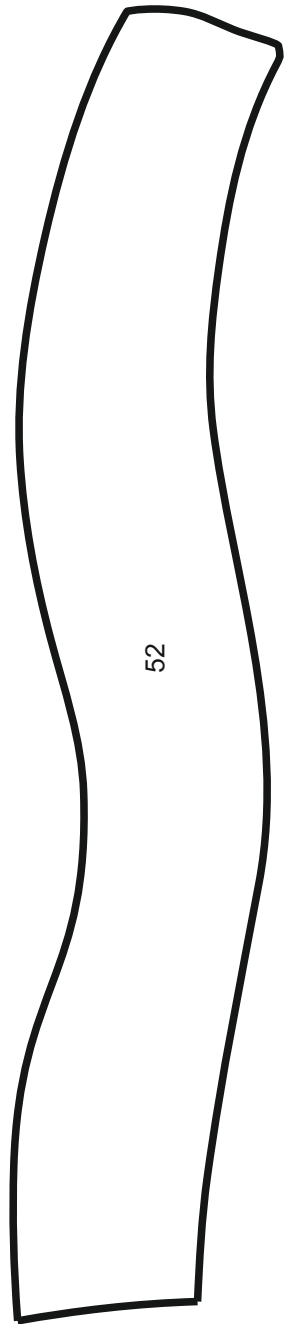

52

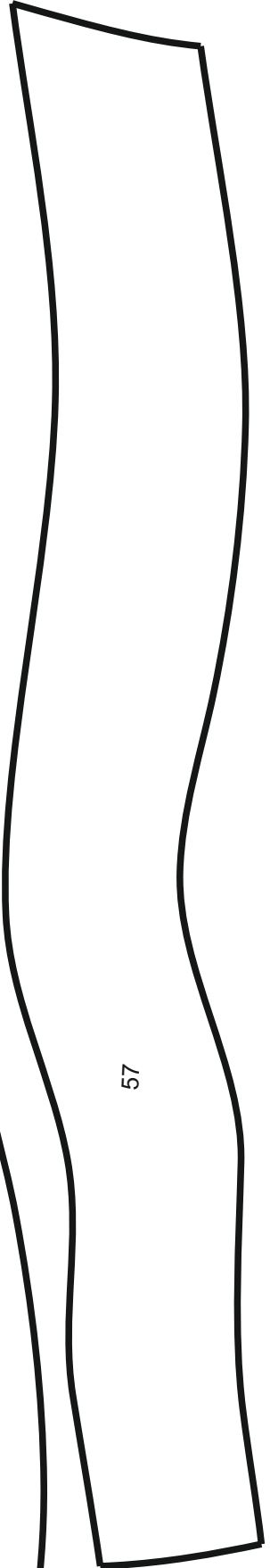
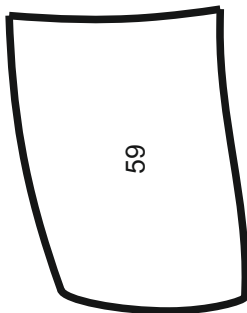
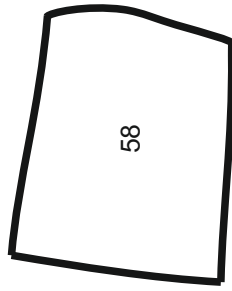
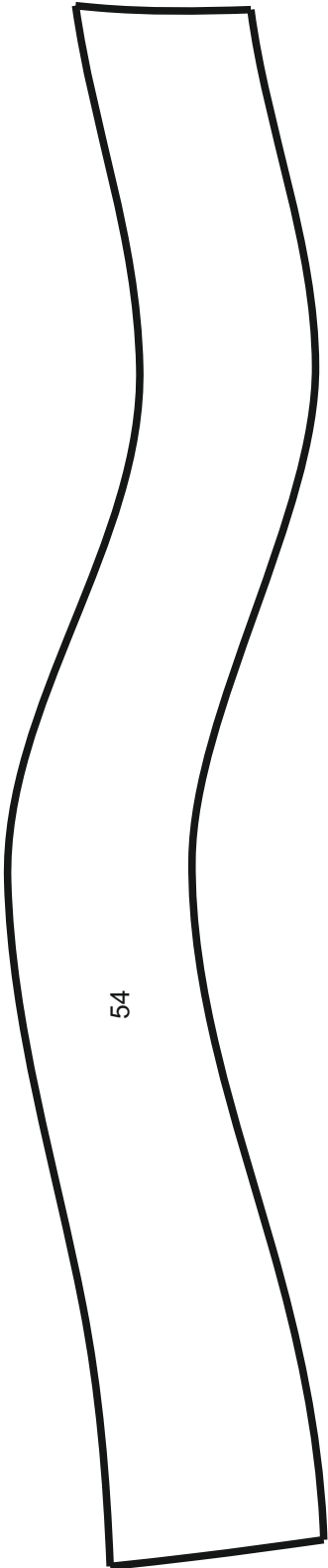
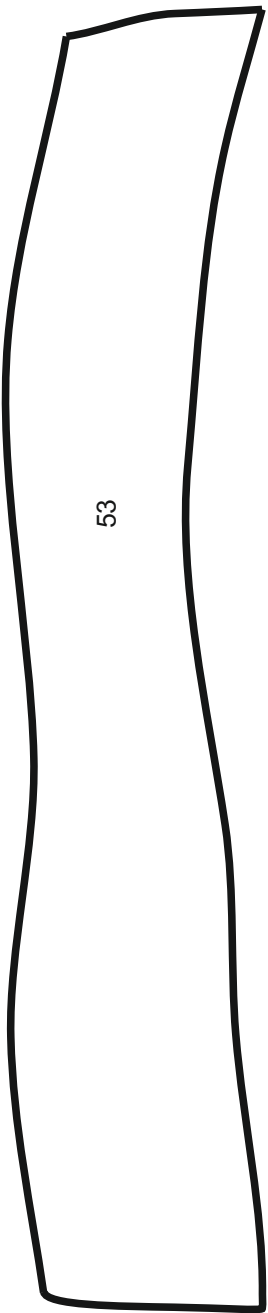

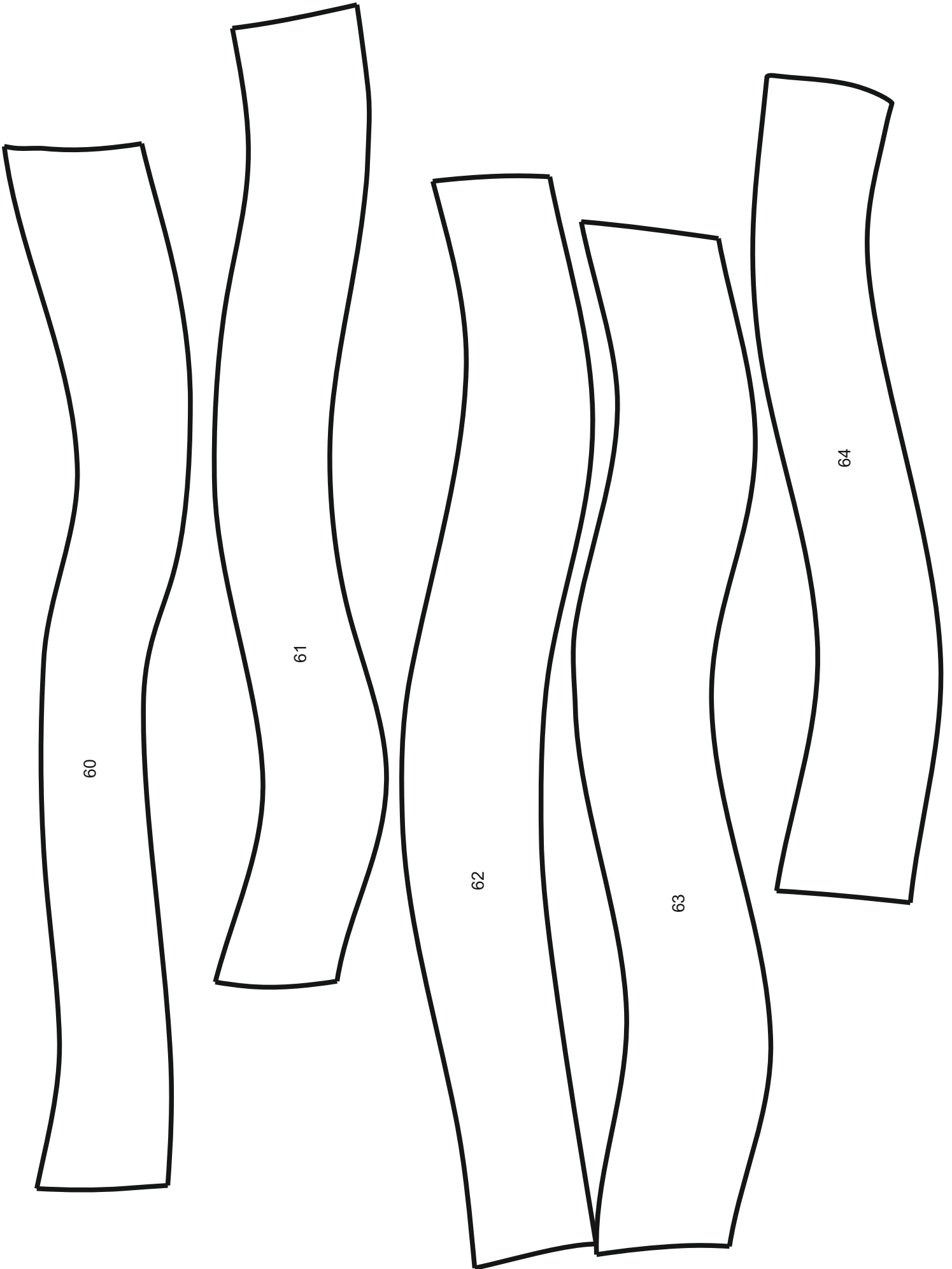

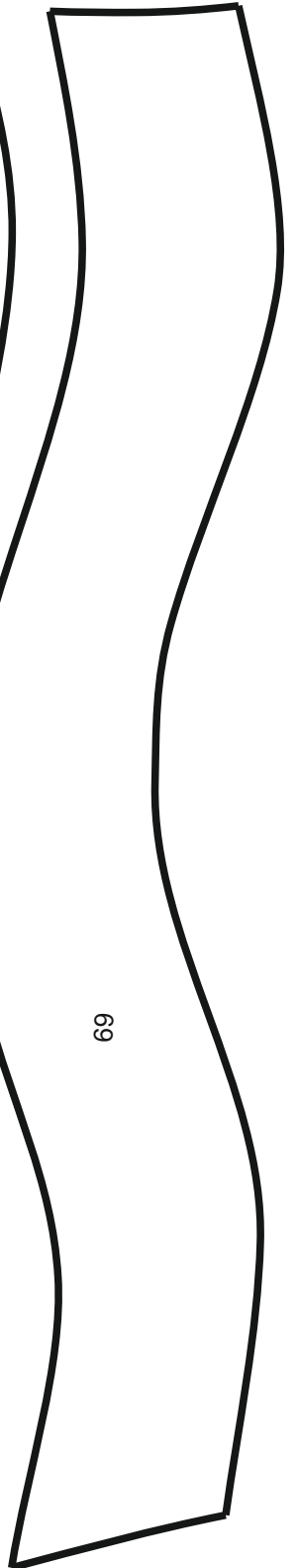
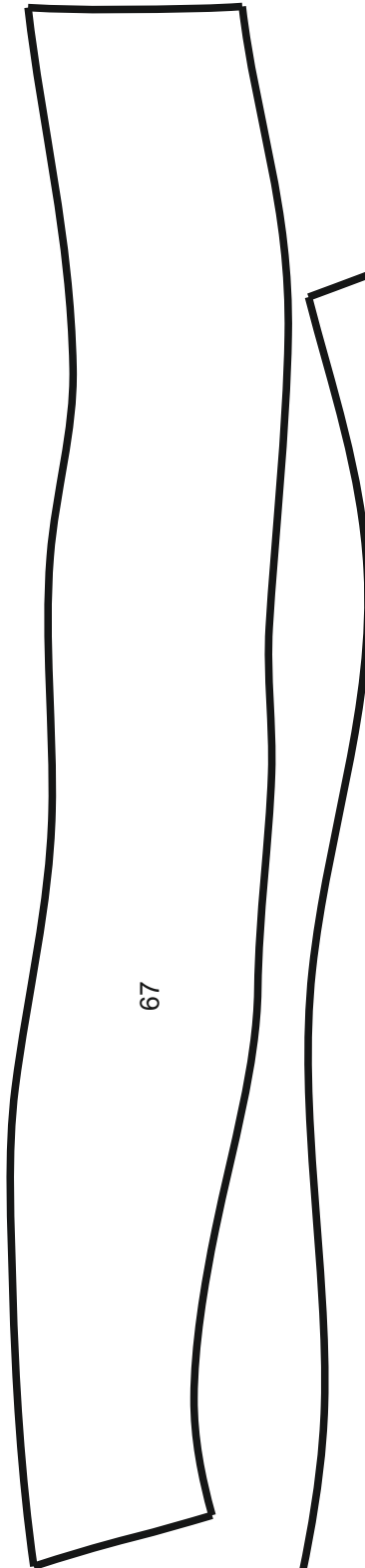
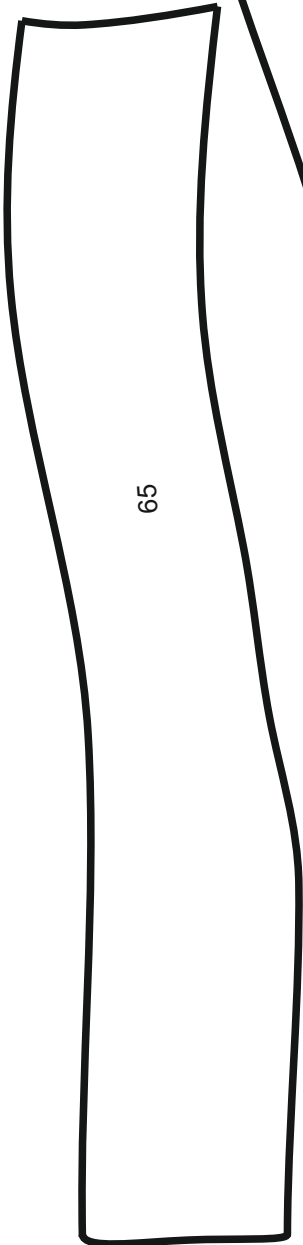

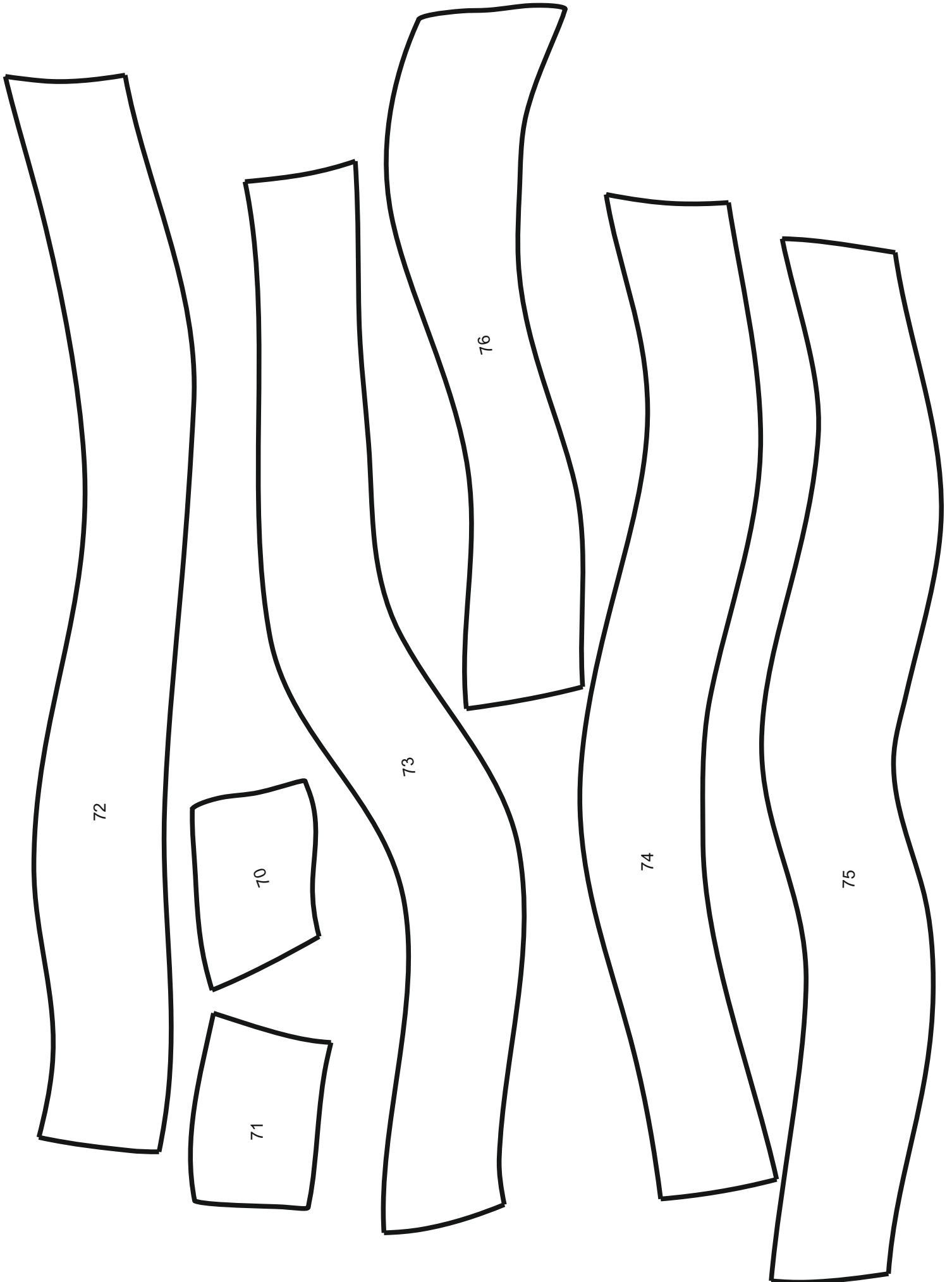

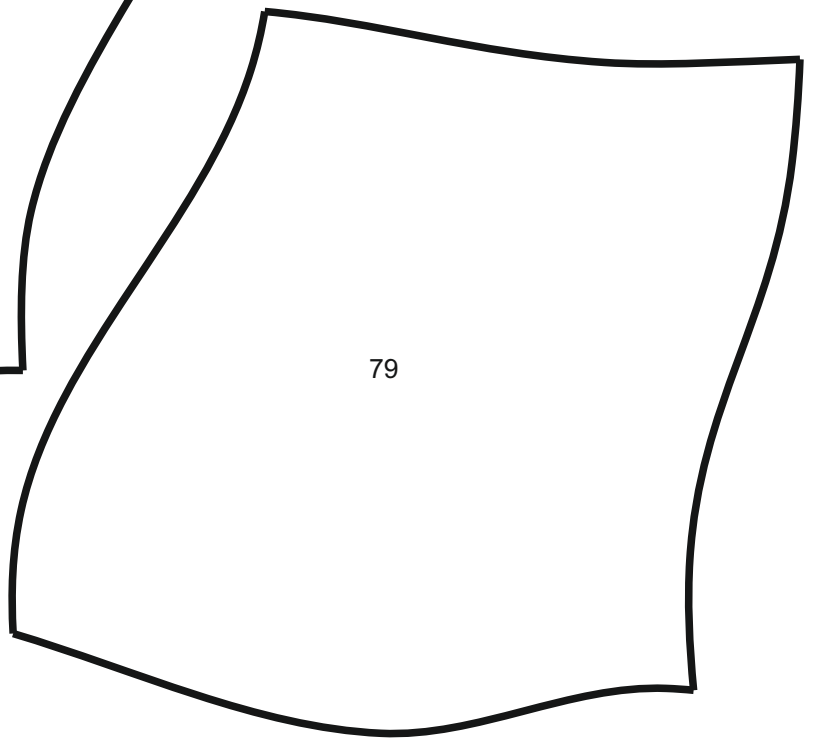
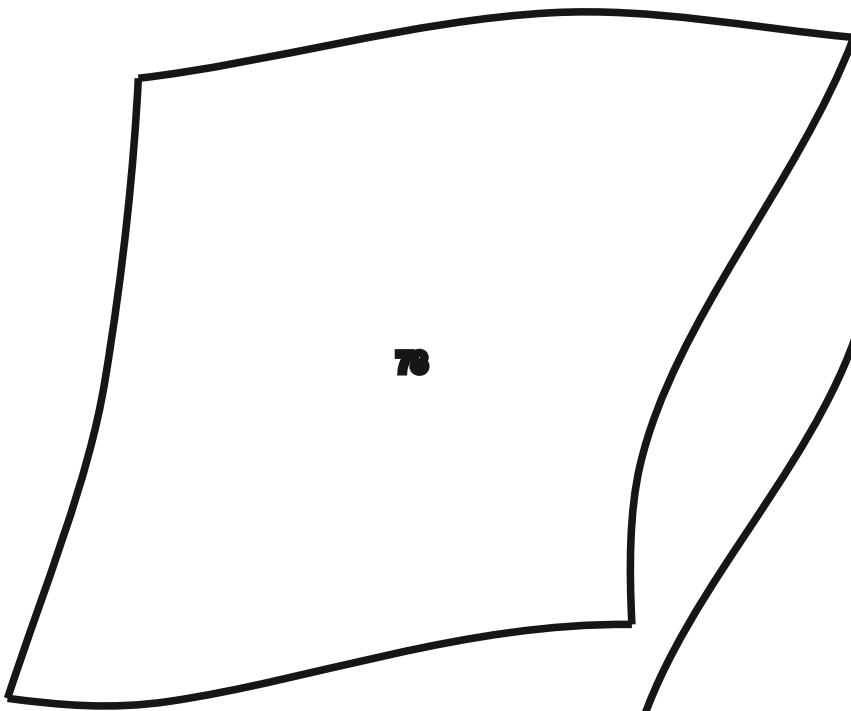
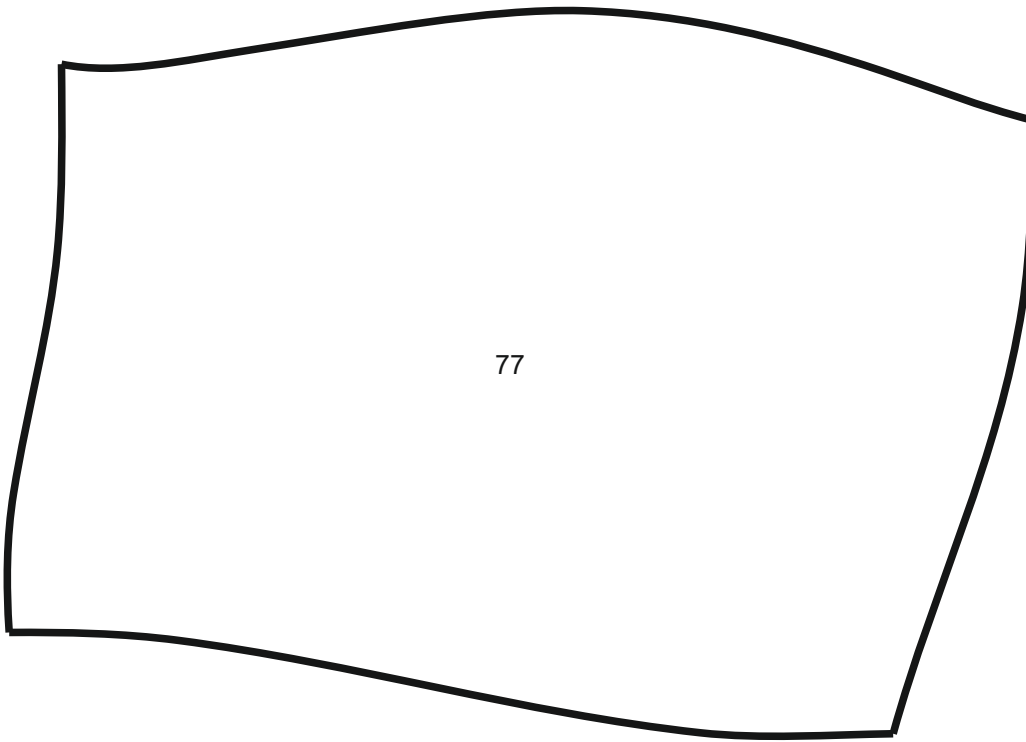

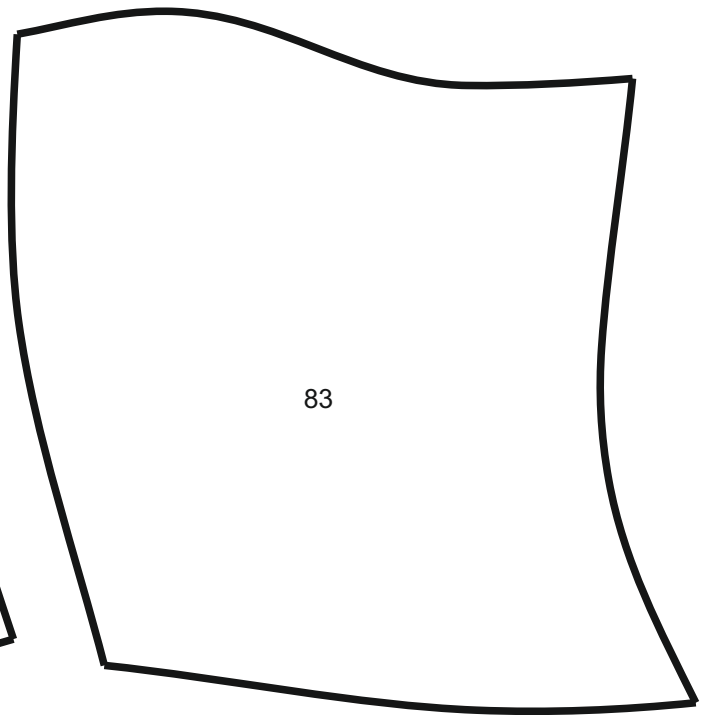
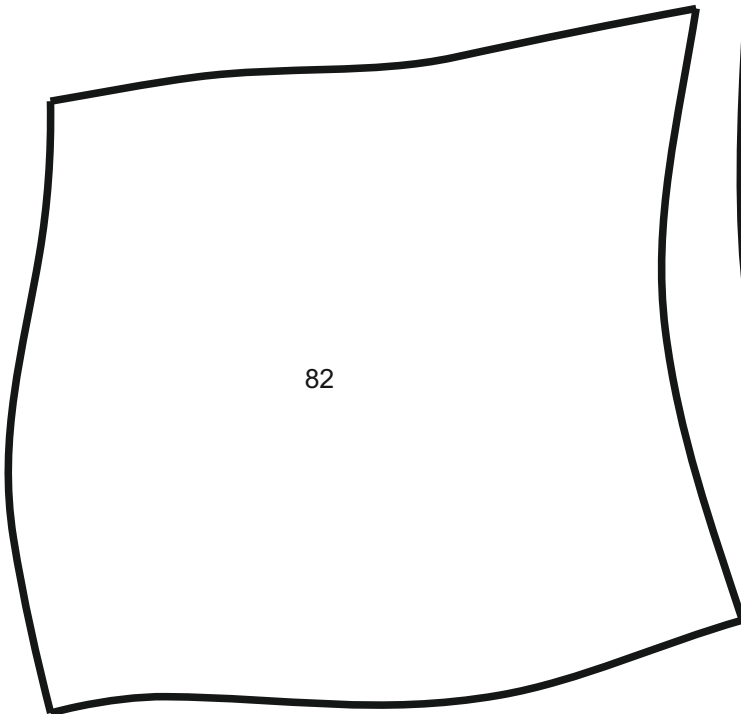
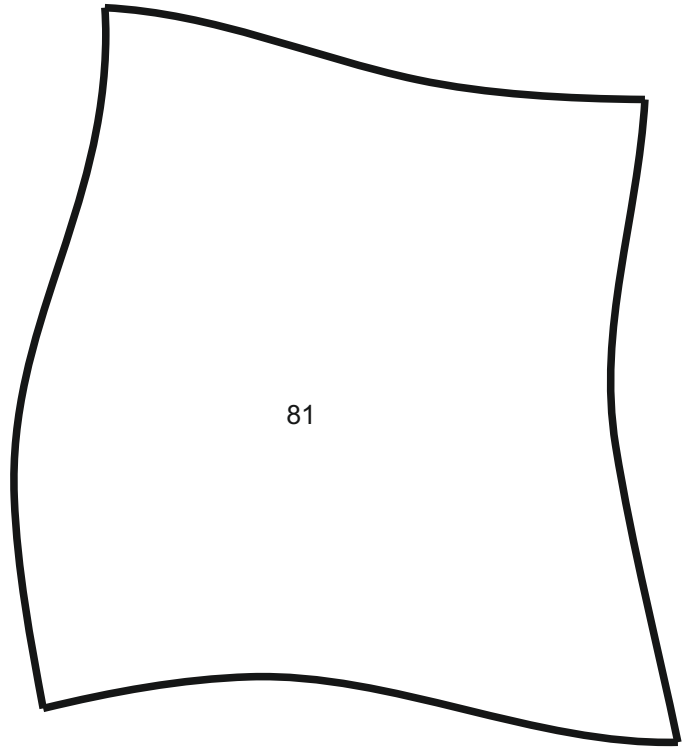
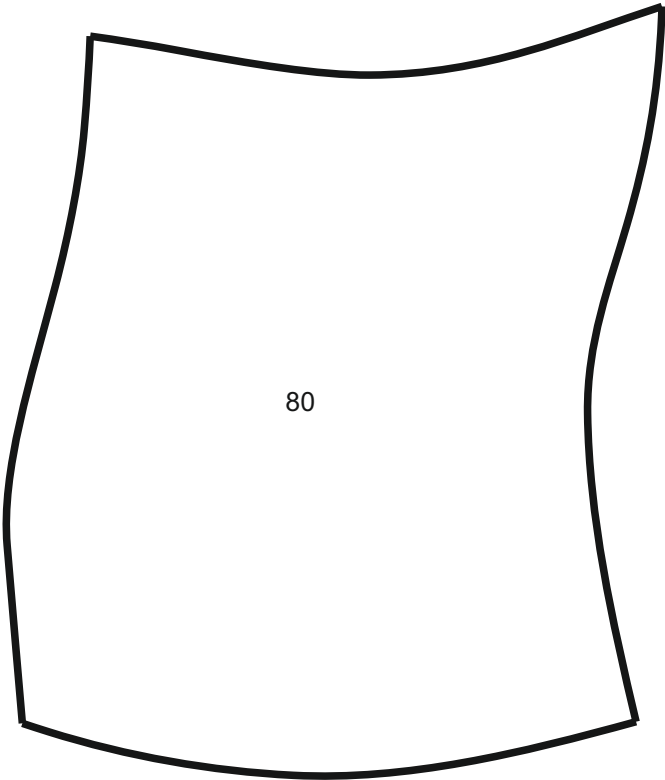

An irregular, roughly rectangular shape with wavy, organic edges. It is oriented horizontally and contains the number 84 in its center.

84

An irregular, roughly rectangular shape with wavy, organic edges. It is oriented horizontally and contains the number 85 in its center.

85

An irregular, roughly rectangular shape with wavy, organic edges. It is oriented horizontally and contains the number 86 in its center.

86

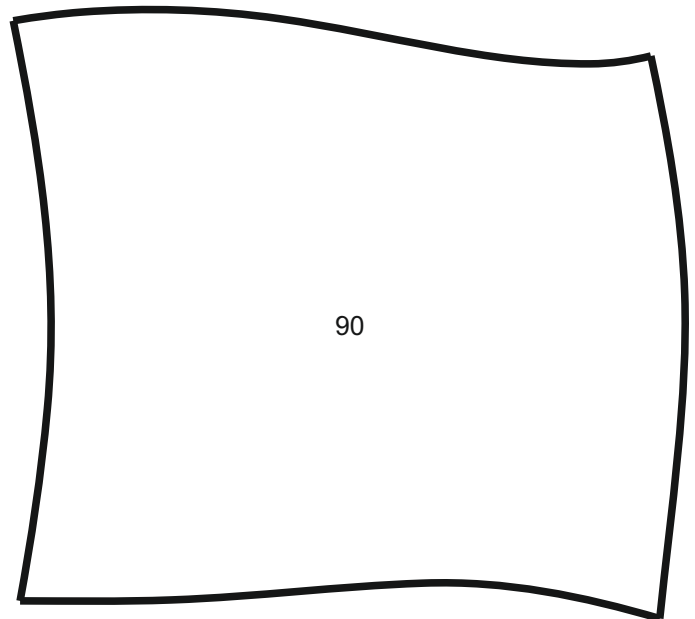
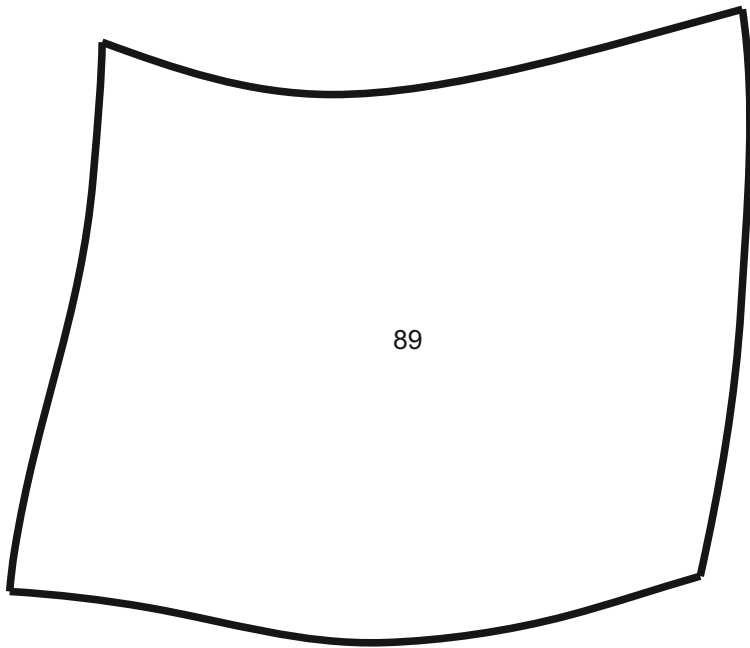
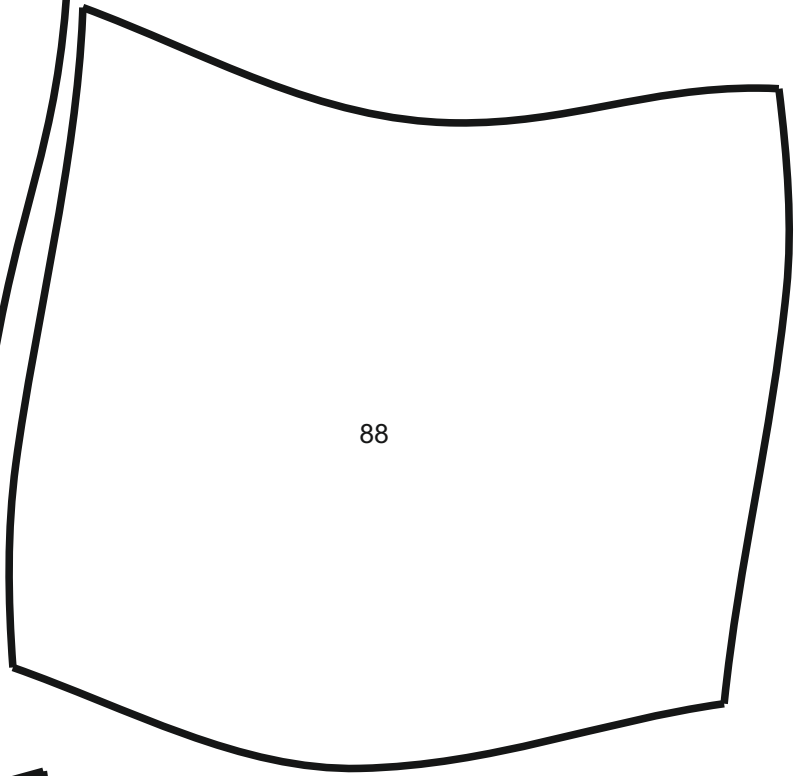
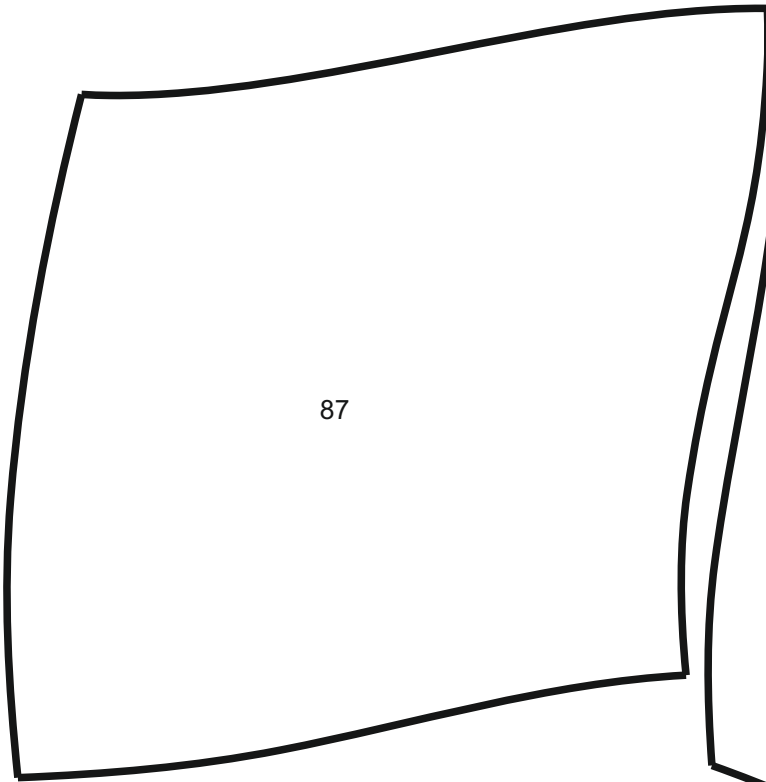

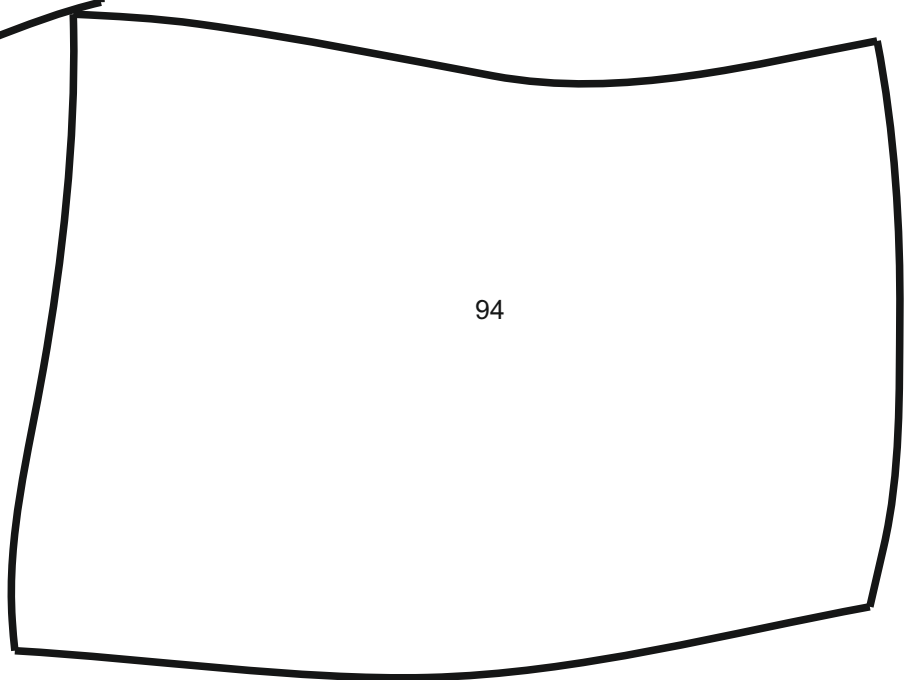
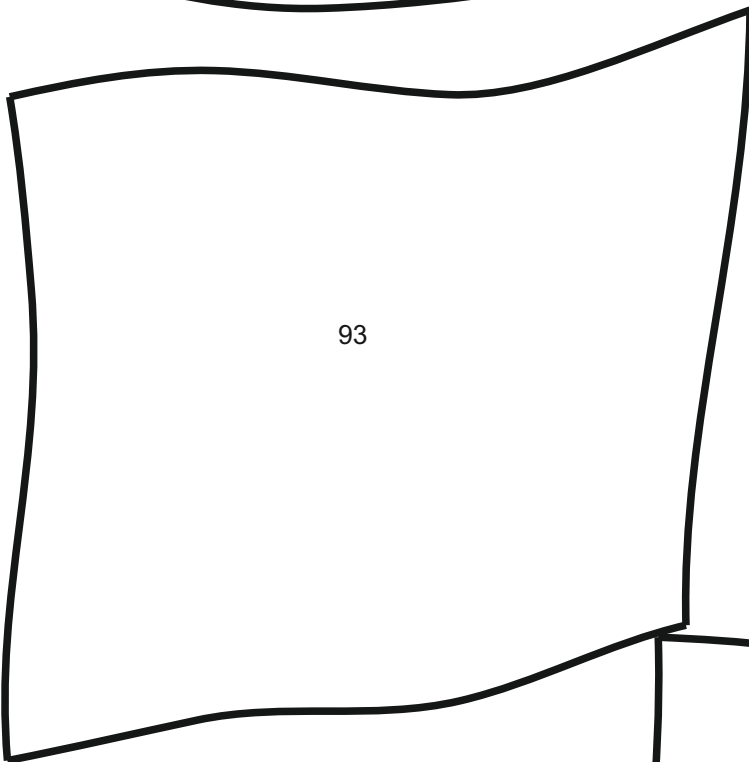
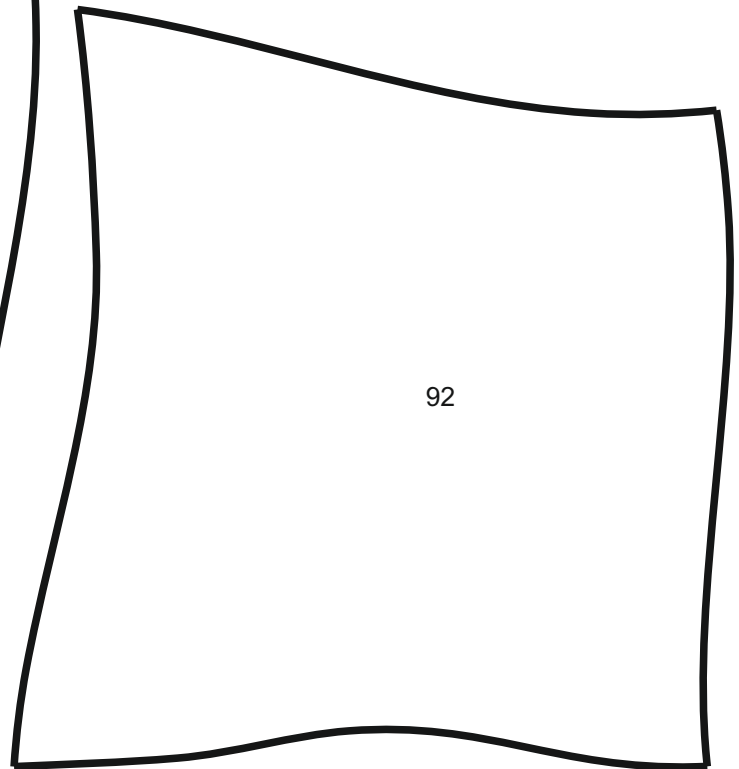
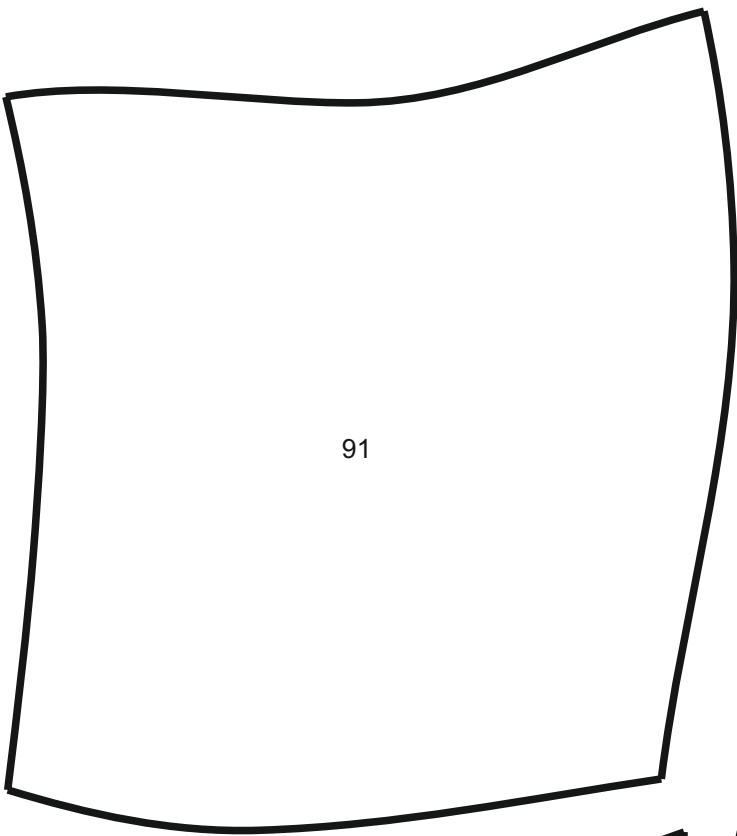

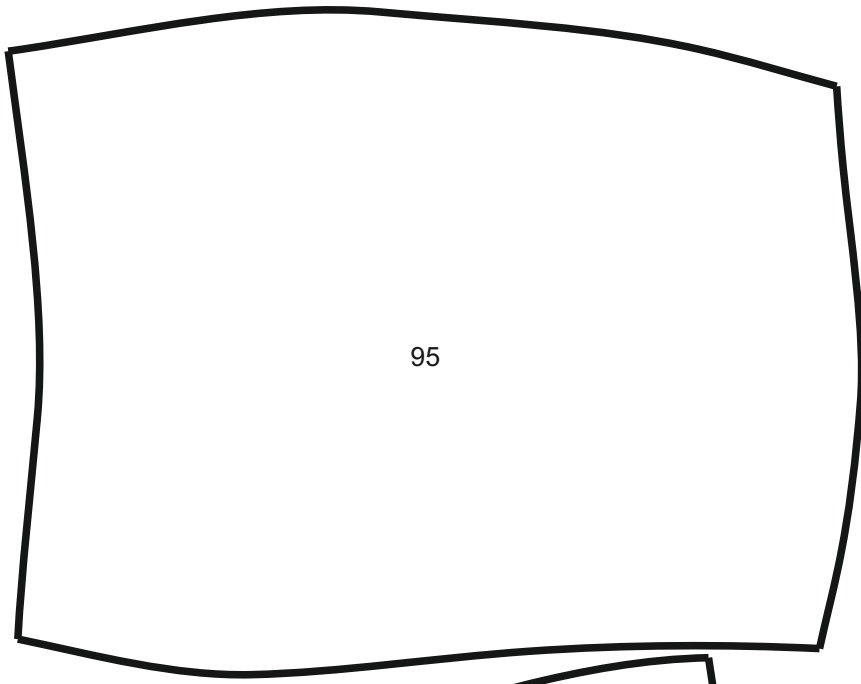

95

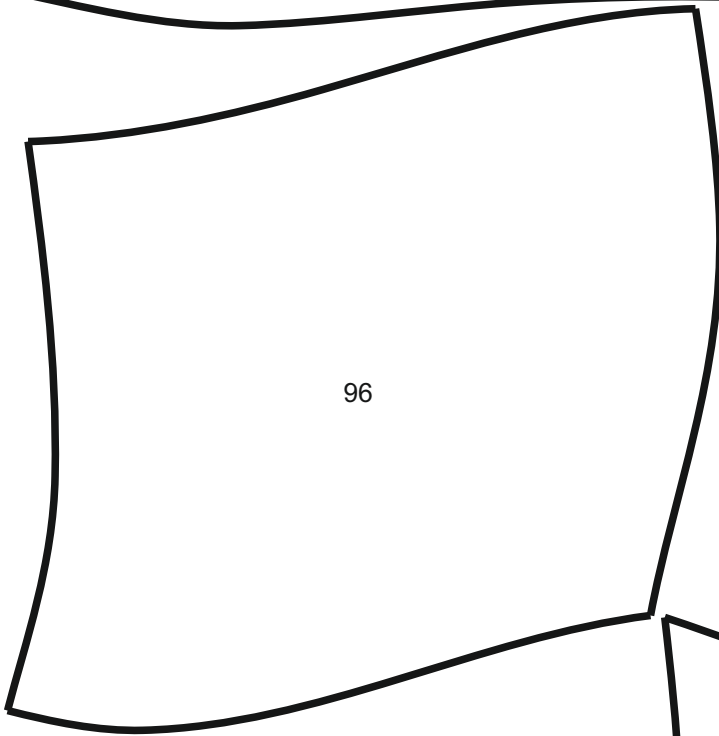

96

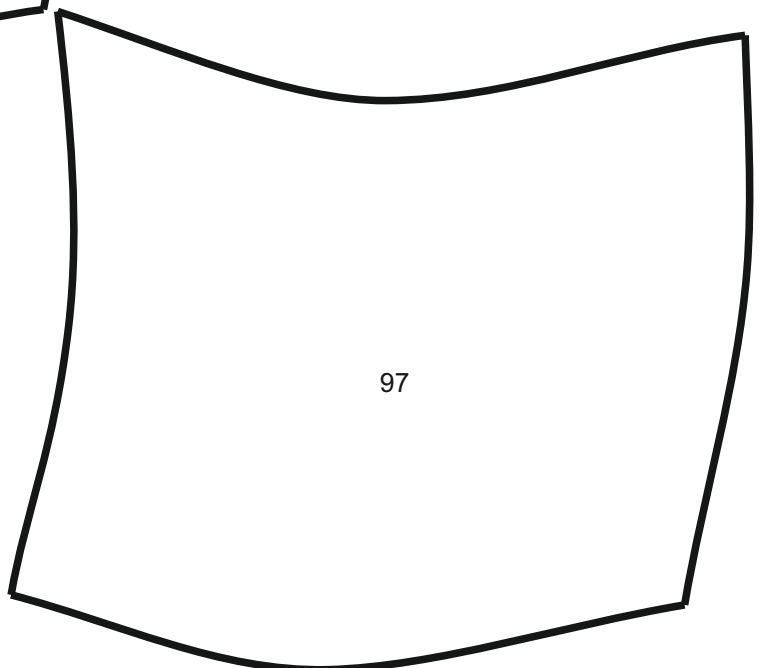

97

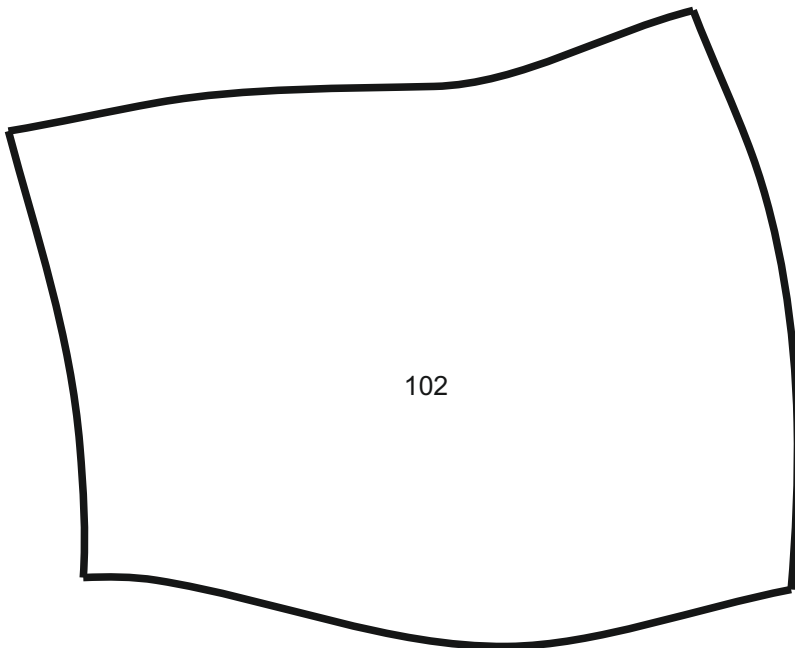
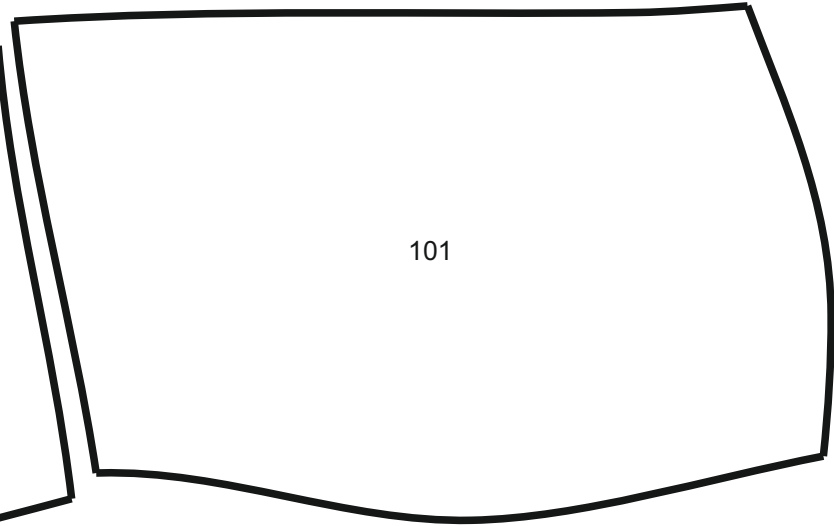
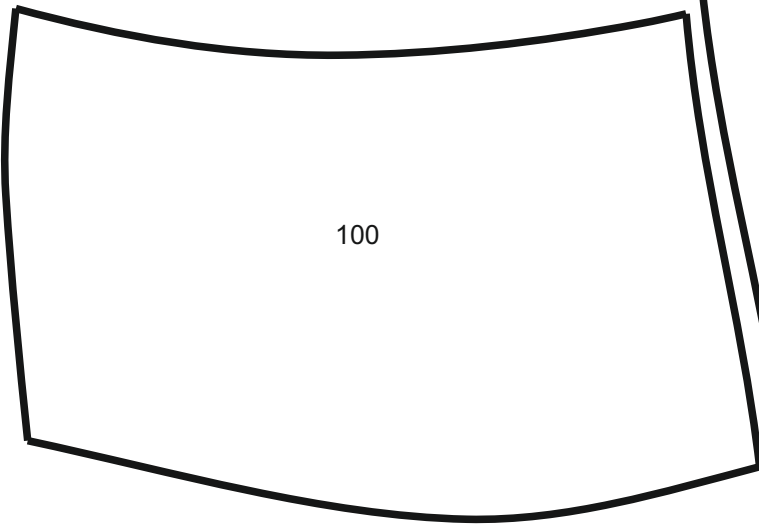
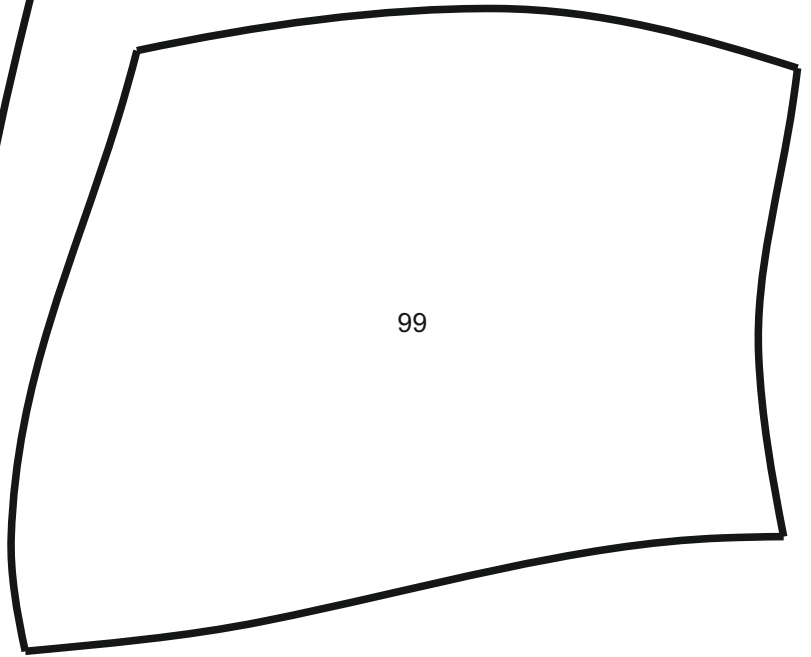
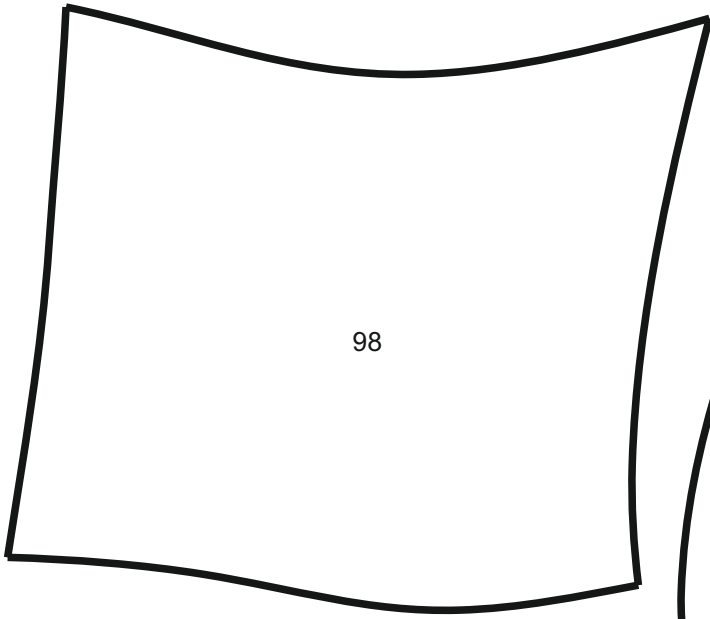

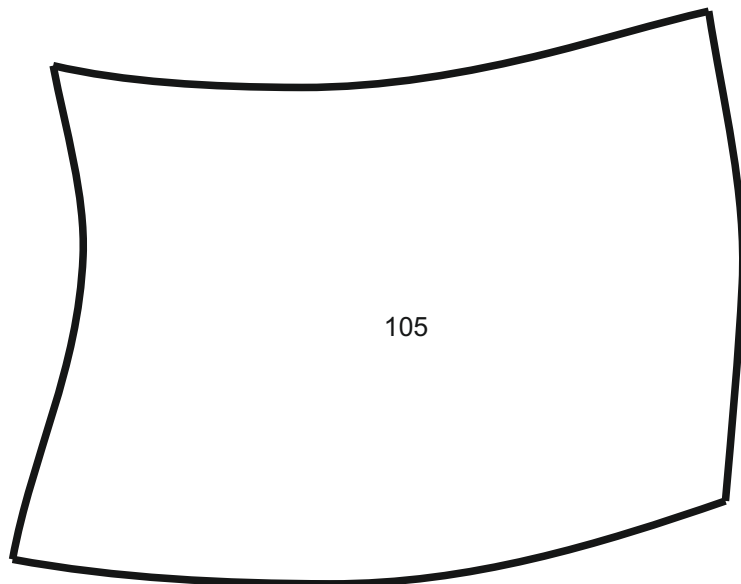
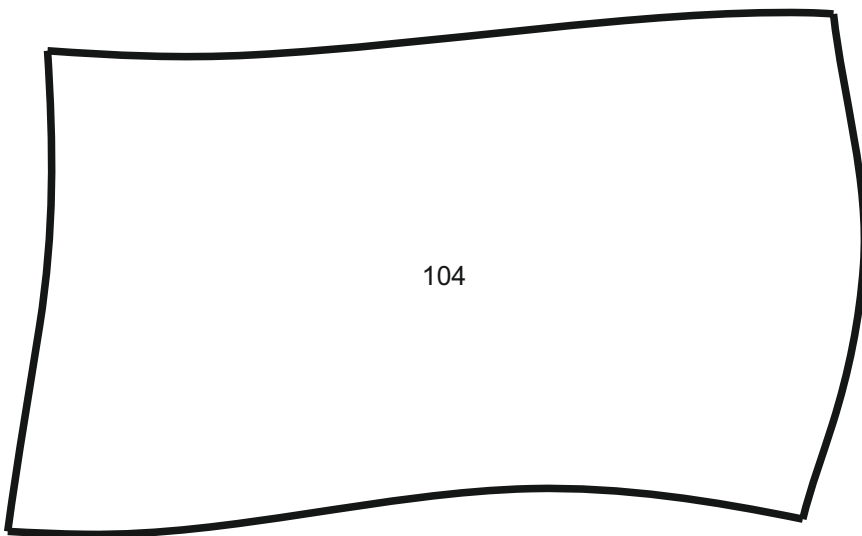
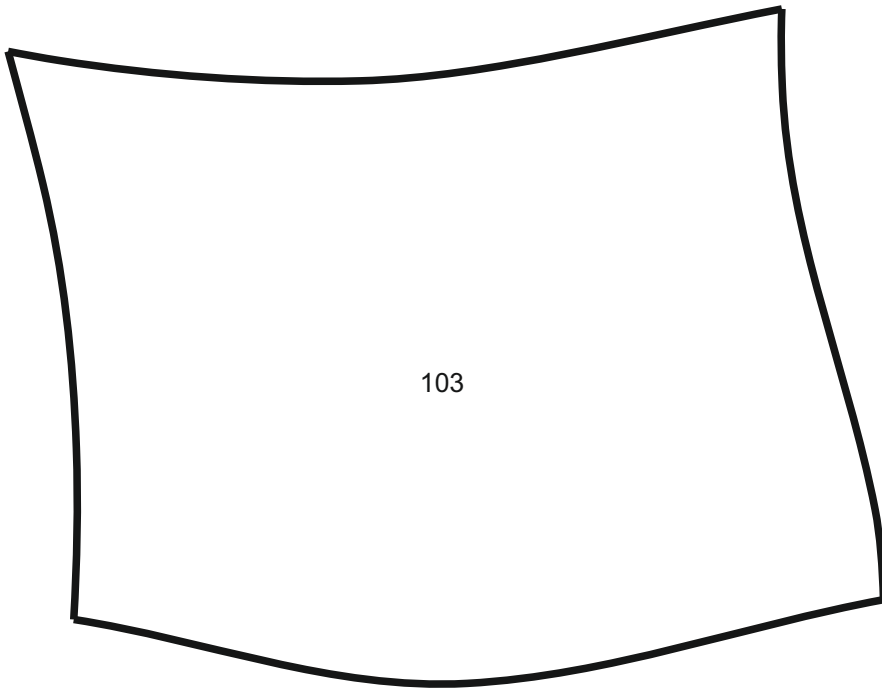

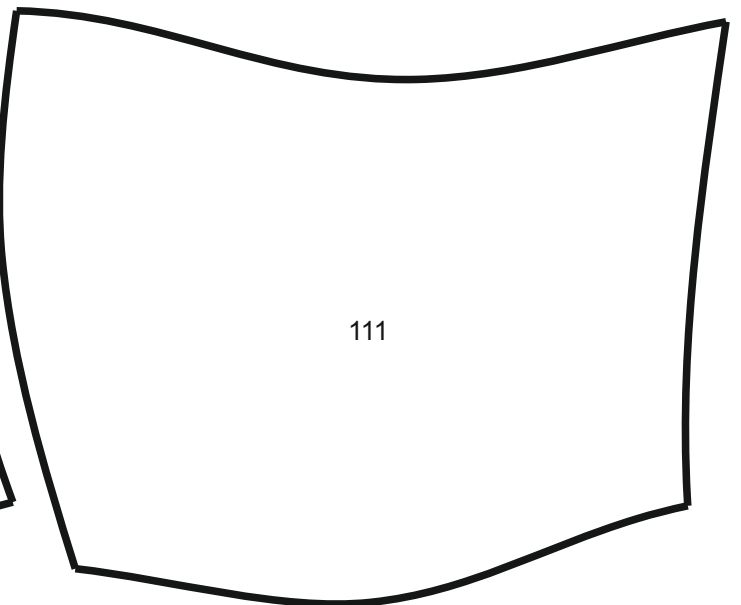
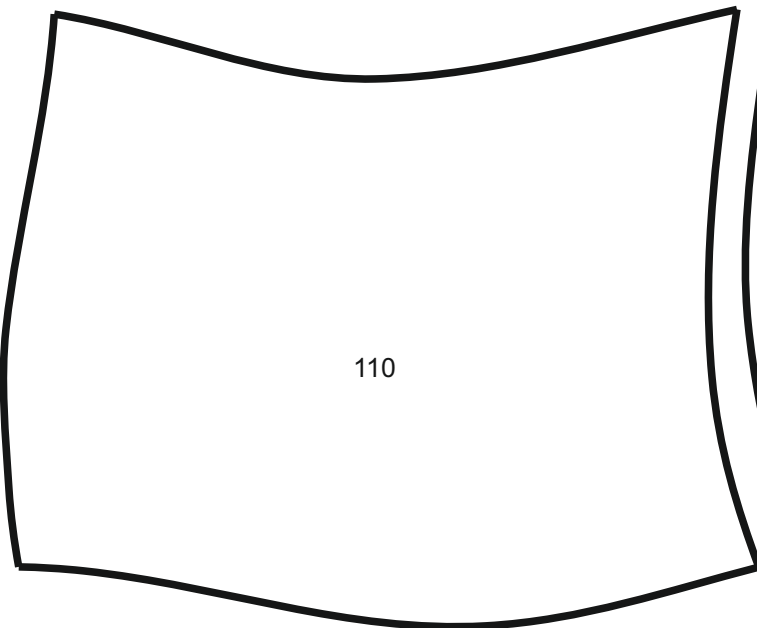
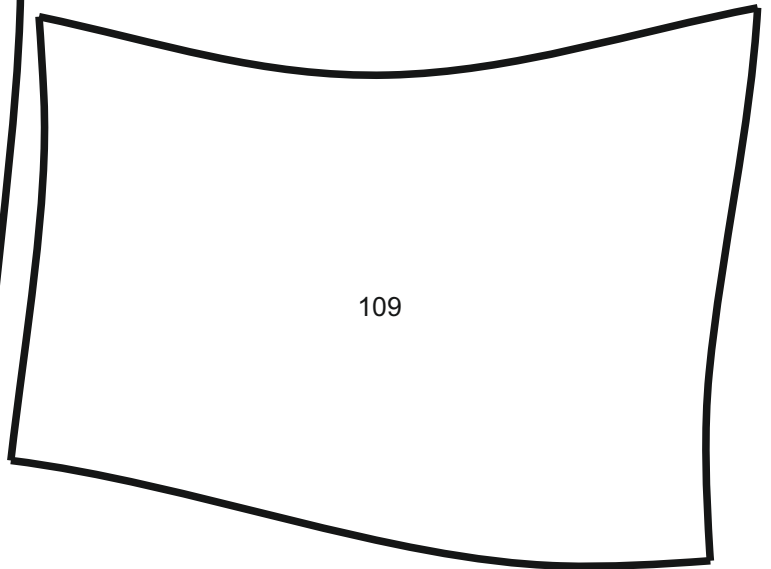
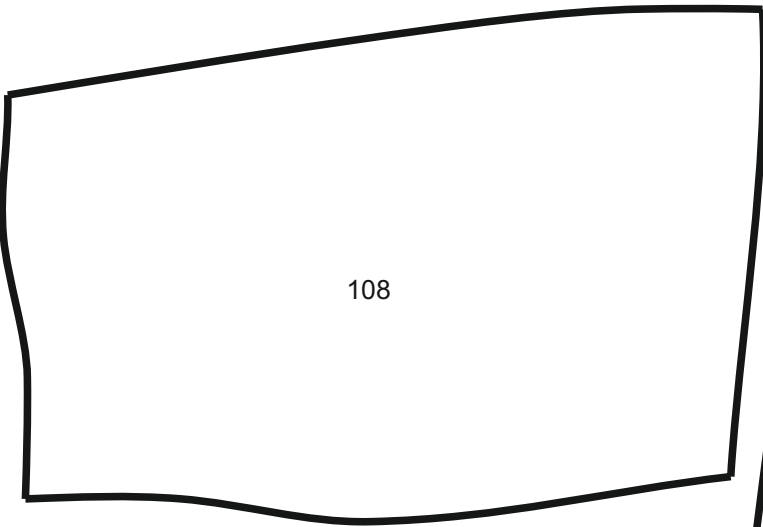
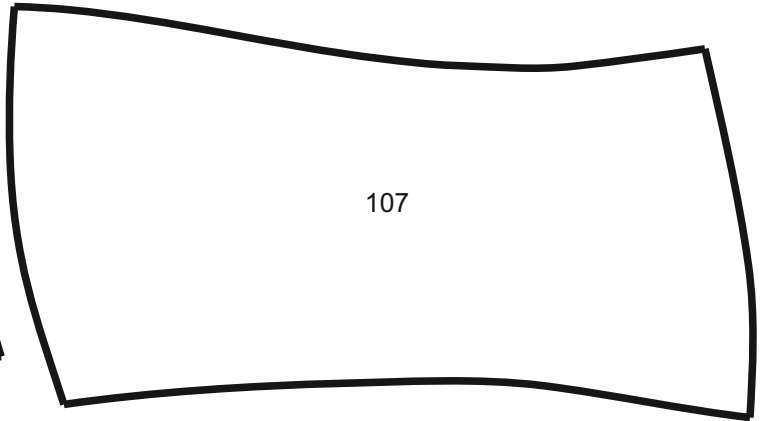
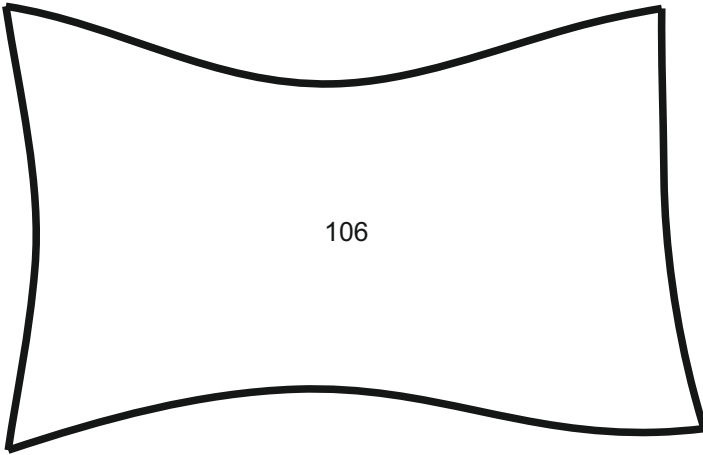

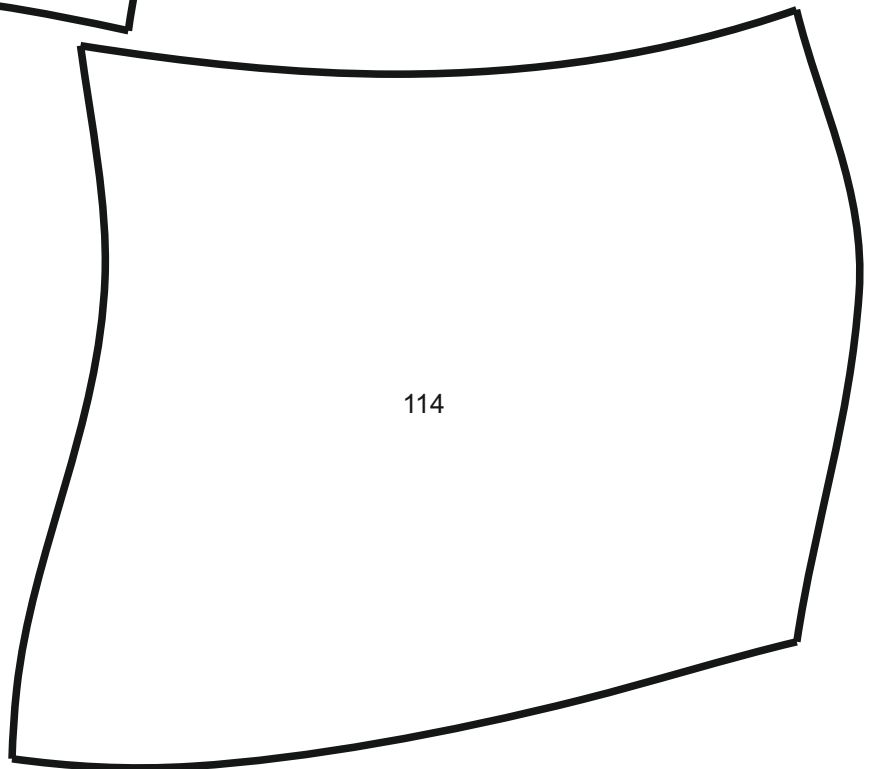
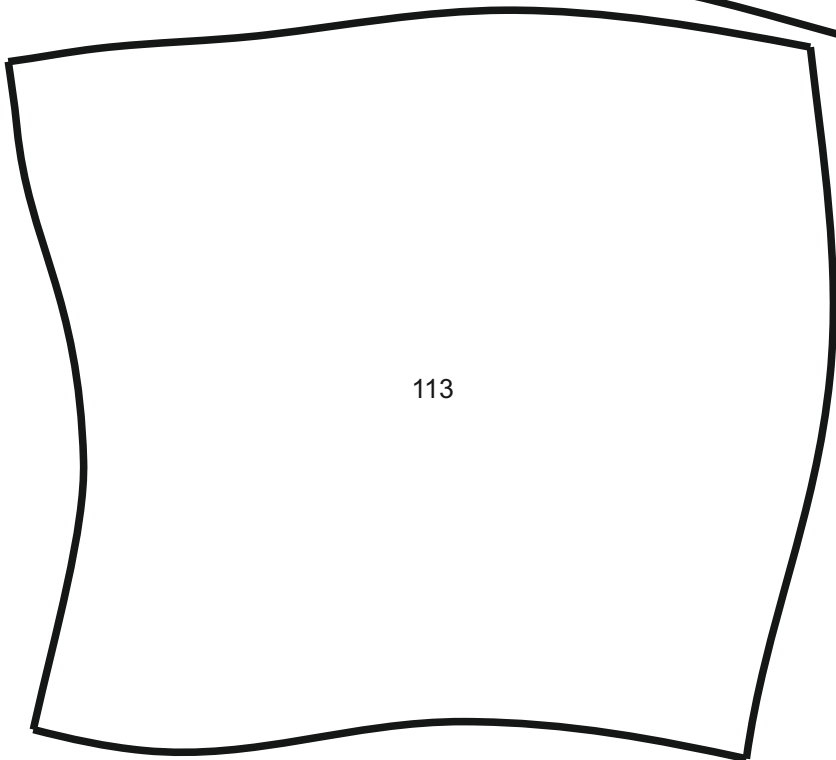
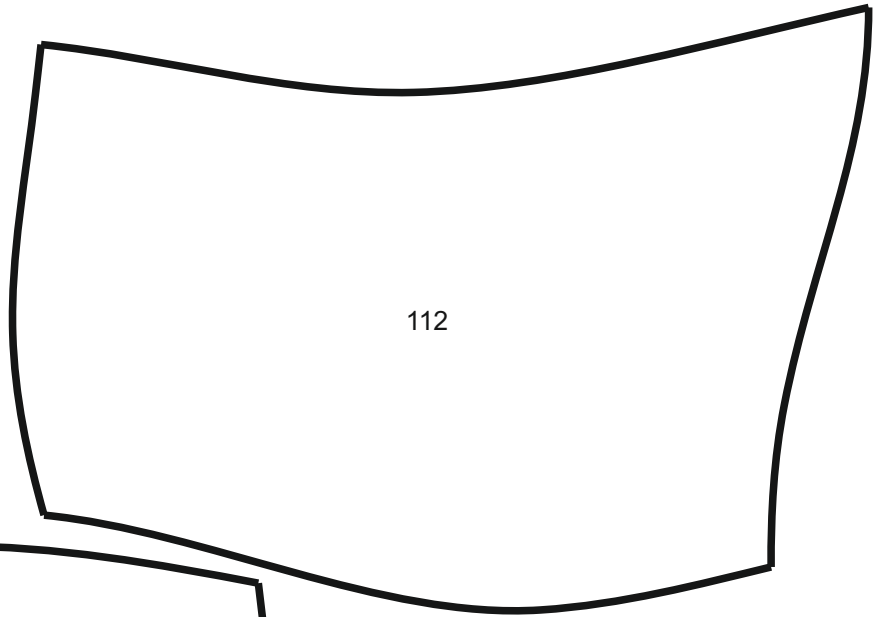

An irregular, roughly square shape with wavy, curved edges. The top edge is slightly curved downwards, the left edge has a small inward curve, and the bottom edge is also curved downwards.

115

An irregular, roughly square shape with wavy, curved edges. The top edge is slightly curved downwards, the left edge has a small inward curve, and the bottom edge is also curved downwards.

116

An irregular, roughly square shape with wavy, curved edges. The top edge is slightly curved downwards, the left edge has a small inward curve, and the bottom edge is also curved downwards.

117

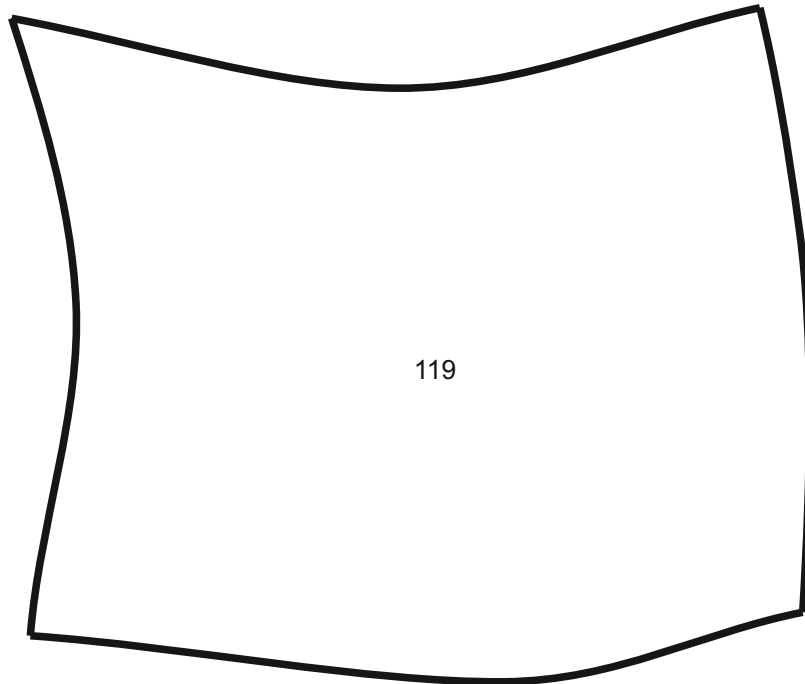
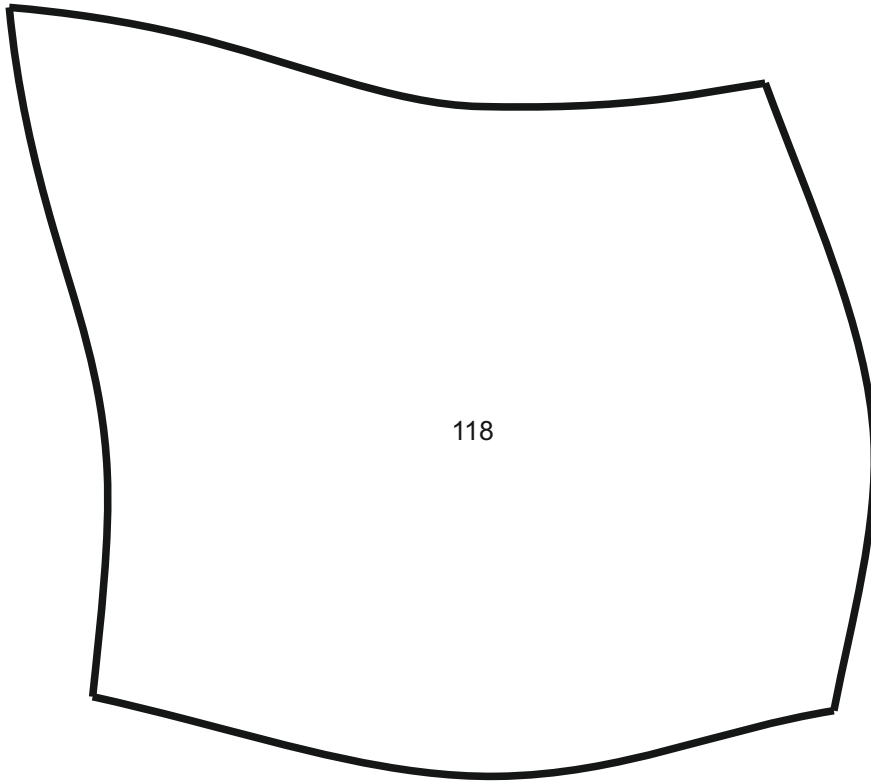

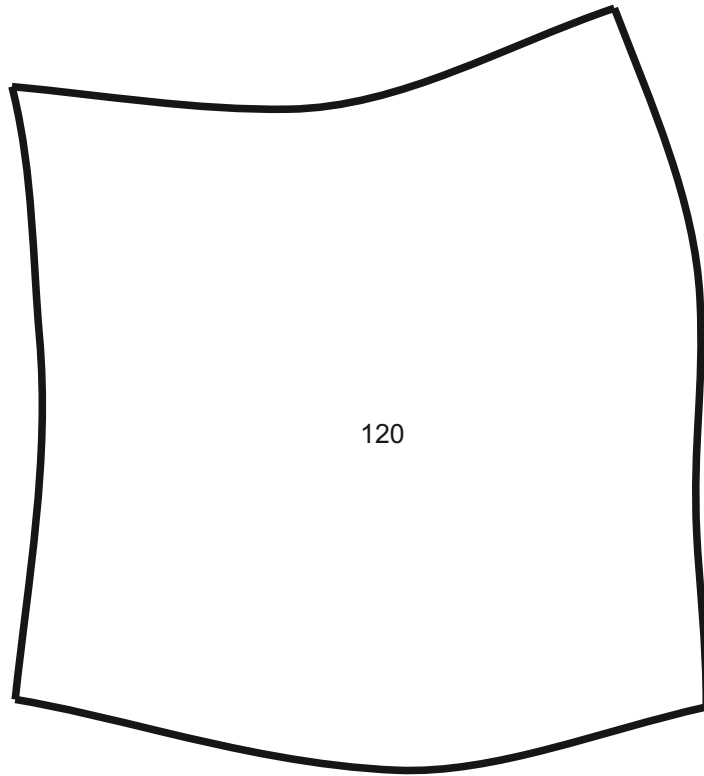

120

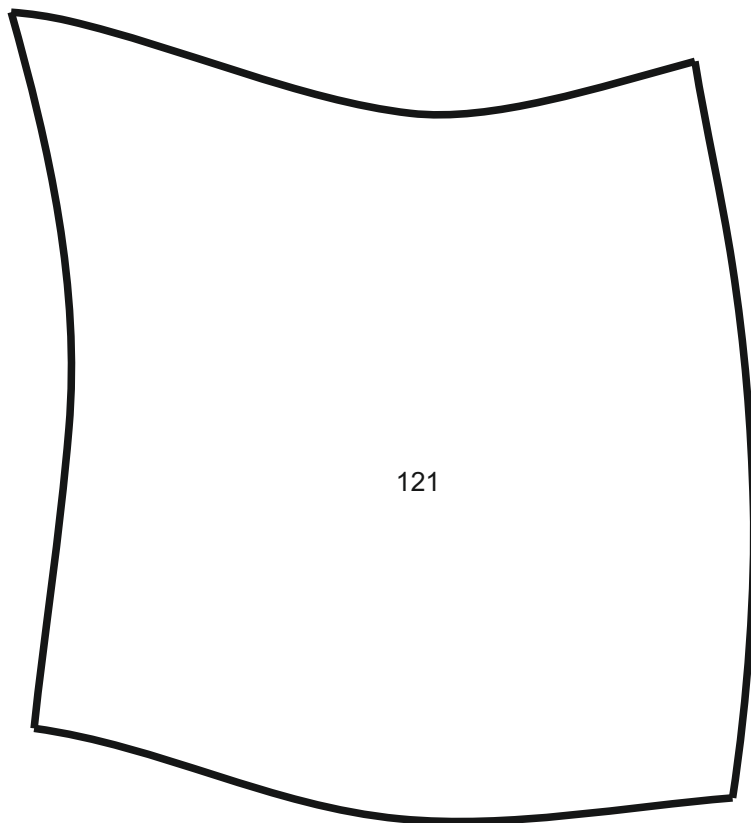

121